

NIOSH Manual of Analytical Methods (NMAM), 5th Edition

Quantification of Airborne Dusts From Powders

by Douglas E. Evans, PhD, NIOSH

1	Introduction.....	AD-2
2	Powders and dusts in the workplace.....	AD-5
3	Dustiness test methods.....	AD-13
4	Key considerations for dustiness.....	AD-38
5	Criteria for current, improved, or new dustiness test configurations	AD-43
6	Summary	AD-44
7	Acknowledgements.....	AD-45
8	References.....	AD-46

DEPARTMENT OF HEALTH AND HUMAN SERVICES
Centers for Disease Control and Prevention
National Institute for Occupational Safety and Health



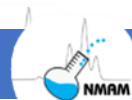

1 Introduction

If powders become airborne as a dust within the workplace, they may pose significant health or safety implications. The relative ease or propensity with which a powder becomes airborne from an external stimulus may be quantified or measured. This attribute may be defined by the term *dustiness*.

This chapter can serve as a helpful guide for industrial and occupational hygienists, safety professionals, environmental health and safety (EHS) managers, EHS investigators, product manufacturers, process engineers, and scientific instrument or equipment manufacturers. This guidance may also be useful to labs focusing on analytical, powder characterization, and process safety. Professionals may find this information helpful both in exploring the value of dustiness testing and in selecting the most appropriate test method for their application.

This chapter briefly discusses how dustiness information may be used to develop low-dust products, inform exposure estimation, and execute risk mitigation, for example, through control banding. The content covers the development of test systems for quantifying dust release from bulk-powdered solids. The various test configurations are categorized according to their underlying dust generation mechanisms: gravity-induced, rotating, fluidization, and aerodynamic. The historical development of the more widely used and standardized test systems is also covered. This information highlights the multiple steps (in some instances) taken to develop and standardize test methods, making this information more readily accessible to the reader. Finally, criteria that need to be considered to evaluate or improve existing test methods or to develop new methods are described, particularly with respect to workplace inhalation exposures.

a. Powders, dusts, and aerosols

Powders, granules, flakes, chips, and pellets are either divided solids, finely divided solids, or particulate solids. These types of divided solids may be created or used across many different industrial sectors. Some are naturally occurring, such as those derived from agriculture, forestry, or through minerals extraction, for example. Others are synthetically manufactured or processed, such as pigments, pharmaceuticals, polymers, resins, or additive manufacturing feedstocks. Powders are the most finely divided solid form. The term “powders” is used more consistently throughout this discussion, but granules, flakes, and pellets may also apply in certain situations. A powder may be defined as finely divided matter or a preparation in the form of fine particles. Powders may therefore be considered as prepared or manufactured (i.e., deliberate or intentional). Conversely, dusts may be considered as waste or having less value. Airborne dust generation is typically unintentional.

The International Standards Organization [ISO 2020] defines dust as “small solid particles, conventionally taken as those particles below 75 μm [micrometer] in diameter, which settle out under their own weight, but which may remain suspended for some time.” The International Union of Pure and Applied Chemistry [IUPAC 1990] defines dust as “small, dry, solid particles projected into the air by natural forces... and by mechanical or man-made processes. Dust particles are usually in the size range from about 1 to 100

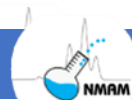

μm in diameter and settle slowly under the influence of gravity.” The World Health Organization [WHO 1999] defines dusts as “solid particles, ranging in size from below 1 μm up to at least 100 μm , which may be airborne or become airborne.” Dust particles with dimensions below 1 μm are often encountered and particles greater than 100 μm may also become airborne [WHO 1999]. The U.S. National Fire Protection Association (NFPA) defines dust as any finely divided combustible solid, less than 500 μm (0.5 mm, or those particles passing a 35 U.S.-mesh sieve), as a potential combustible hazard [NFPA 2022]. Therefore, from the broad occupational health and safety perspective, dust may span a particle size range from below 1 μm through 500 μm .

The scientific and universal term “aerosol” may be defined as a disperse system of liquid or solid particles suspended in a gas, usually air [ACGIH 1999; Hinds 1999; Vincent 1995, 2007]. Aerosol may describe dispersed liquid particles, such as mists or sprays [Vincent 1995]. This can include newly condensed particles from a gas or vapor, more commonly referred to as fumes [Hinds 1999]. We will not consider mists, sprays, and fumes any further in this discussion.

When a powder or dust becomes airborne, the resulting suspension is an aerosol. Aerosol is the correct scientific term, but we use the terms dusts or airborne dusts more consistently in this chapter as they are in wider general usage outside of the scientific research community.

b. Dust generation from powders

A powder will remain at rest or at a stable equilibrium until some external stimulus is applied. This situation differs from an analogy sometimes made with vapors that result from volatile liquids, for example, where vaporization is a spontaneous process. Within a liquid at rest, sufficient internal energy exists to facilitate vapor release from the liquid surface into air. For a finely divided solid at stable equilibrium, the energy required to release particles into air, and overcome interparticle attractive forces, must come externally.

For powder to become an airborne dust, there needs to be a coupling of at least two phases. At a minimum, this involves the mixing of powder and air. In further instances, the interaction of a powder, air, and a solid surface (a bench or floor for example) contributes to generating airborne dust. The stimuli can be applied in many ways. Gravity acting on the powder can result in some portion of the powder becoming airborne if the powder is set in motion. For example, an unstable powder pile (at unstable equilibrium), initially at rest, may cascade down, a portion of which may be entrained within the resulting displaced air. In another example, a poured powder can produce turbulent air currents as it displaces air, entraining and dispersing particles as it does. The impact of a bolus of falling powder with a solid surface can also result in some fraction of the powder being entrained. The dry sweeping of a spilled powder, perhaps with a brush or broom, would also likely result in some fraction of the powder becoming airborne. As the bristles move, they stir and agitate both the powder and air. These examples would generally be considered mechanical stimuli.



One further noteworthy scenario is the induced movement of air over a finely divided solid or powder. This may be the result of wind (i.e., an Aeolian process) [Bagnold 1941; Cowherd 1981; Gillette et al. 1974; Visser 1992] or forced mechanical ventilation. Air movement might also result from fast-moving and energetic compressed air used during industrial processes, materials conveyance, cleaning operations, or pneumatically powered equipment operations, for example. These examples are considered aerodynamic stimuli, resulting from some fraction of the powder breaking away from the bulk and becoming entrained within the induced airflow.

Other airborne dust-generation mechanisms exist that are not discussed further in this chapter but may be the result of direct comminution (size reduction) from bulk solids. Comminution of parent bulk materials may include, for example, crushing, machining, grinding, drilling, sanding, scraping, etc. From the perspective of this discussion, airborne dust generation is the conversion of some fraction of the powder into an airborne dust.

c. Dustiness

The physical properties of a powder may influence the quantity of airborne dust liberated and can be considered a source strength factor [Lidén 2006]. The term “dustiness,” first used by Powell and Russell [1933] to describe the dust-generating ability of coal and coke, was undefined. The term dustability was used briefly [Bransby 1977; Schofield et al. 1978], but dustiness has seen far wider usage, both historically and geographically. We continue here with the dustiness terminology.

An early definition of dustiness was “the tendency of dry materials to liberate dust into the air when handled under specified conditions” [BOHS 1985]. This definition referred to materials transfer and processing operations, but notably did not include the (direct) generation of particles during deliberate comminution [BOHS 1985], noted in the previous section. A further step could be added to this definition that addressed handling the collected dust generated from comminution.

Chung and Burdett [1994] argued that there was no unique definition of dustiness, as all dustiness measures were empirical and method dependent. Lyons and Mark [1994] defined dustiness as the “propensity of materials to form airborne dust,” and Lidén [2006] defined it as the “propensity of a material to generate airborne dust during its handling.”

Boundy et al. [2006] defined dustiness as the “tendency of a powder to form an aerosol after it receives a given energy input.” The finely divided solid or powder, as discussed earlier, requires an external mechanical or aerodynamic stimulus to produce the airborne dust, and at least two (or even possibly three) phases are required. An inclusive definition of dustiness, therefore, may be the following: the propensity of a finely divided solid to form an airborne dust (aerosol) by a mechanical or aerodynamic stimulus.

Chung and Burdett [1994] and Lidén [2006] noted that dustiness is not an intrinsic powder property but is influenced by the selected test method. While not an intrinsic

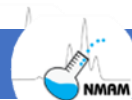

material property, dustiness is a property of a given powder that should be quantifiable and reproducible under a given controlled testing protocol [Evans et al. 2013]. With the many dustiness techniques developed, one simple approach to comparing results is through standardization, as noted by Chung and Burdett [1994].

Standardization from an occupational inhalation exposure perspective was proposed as early as 1980 [Hammond 1980]. The British Occupational Hygiene Society (BOHS) formed a technical working group in 1980 to review available test methods and recommend a standard dustiness approach [BOHS 1985]. It is now well recognized that different test configurations (i.e., different underlying dust generation mechanisms with varying particle sampling arrangements) will provide different dustiness results. For example, of the two standardized test configurations described in the European Standard EN15051, “Workplace atmospheres—Measurement of the dustiness of bulk materials” [CEN 2013b,c], powders tested under each configuration do not consistently rank in a similar manner [e.g., Pensis et al. 2010].

1) Primary particles, aggregates, and agglomerates

Powders are comprised of primary particles, which in some instances may be further aggregated, fused, or sintered together very strongly. These strongly bonded particle assemblies are sometimes referred to as aggregates or hard agglomerates [Friedlander 2000]. Primary particles (or aggregates, if present) may be further held together by relatively weak adhesive particle interactions (e.g., van der Waals, electrostatic, capillary, and morphological interlocking). These latter loosely held structures are generally referred to as agglomerates [Nichols et al. 2002].

Although it is relatively easy to break up the loose agglomerates, breaking up aggregates into their primary particles often requires considerable mechanical action (ball-milling, for example). The fracture or further comminution of primary particle size can only be achieved with extreme difficulty. In dustiness testing, the energy supplied is insufficient to divide primary particles or break up strongly bound aggregates/hard agglomerates made up of primary particles [Evans et al. 2013]. However, the energy supplied may be enough to overcome interagglomerate adhesion and separate some fraction of the agglomerates from the bulk powder. The deagglomeration of a fraction of the loosely held agglomerates, which constitutes the bulk powder, is responsible for airborne dust generation.

2 Powders and dusts in the workplace

If powders, dusts, or finely divided solids are permitted to become airborne, forming an aerosol, they may potentially pose a health hazard or a safety hazard or both in workplaces across multiple industrial sectors.

a. Relevance of airborne dusts to occupational health

Airborne dusts or aerosols in a broader context, can be inhaled and enter the respiratory system as an inhalation exposure. Particle penetration and deposition within the respiratory system are largely influenced by particle size or aerodynamic particle

diameter. The particle health-based size fractions, inhalable, thoracic, and respirable, provide information on where particles are capable of penetrating and further depositing within the respiratory system [ACGIH 1999].

Inhalable (\sim PM100) particles are those that may enter the mouth or nose; thoracic (\sim PM10) particles pass the larynx and into the conducting airways; and respirable (\sim PM4) particles may penetrate the unciliated or gas-exchange regions of the respiratory system [ACGIH 1999; CEN 1993; ISO 1995]. The health-based particle penetration curves and their mathematical approximations are discussed in ACGIH [1999], Hinds [1999], and Vincent [2007]. They are also shown in Figure 1. The U.S. Environmental Protection Agency (EPA) ambient air quality particulate matter fractions for PM10 and PM2.5, which were developed independently of ACGIH [1999], CEN [1993], and ISO [1995], are included for comparison [Hinds 1999].

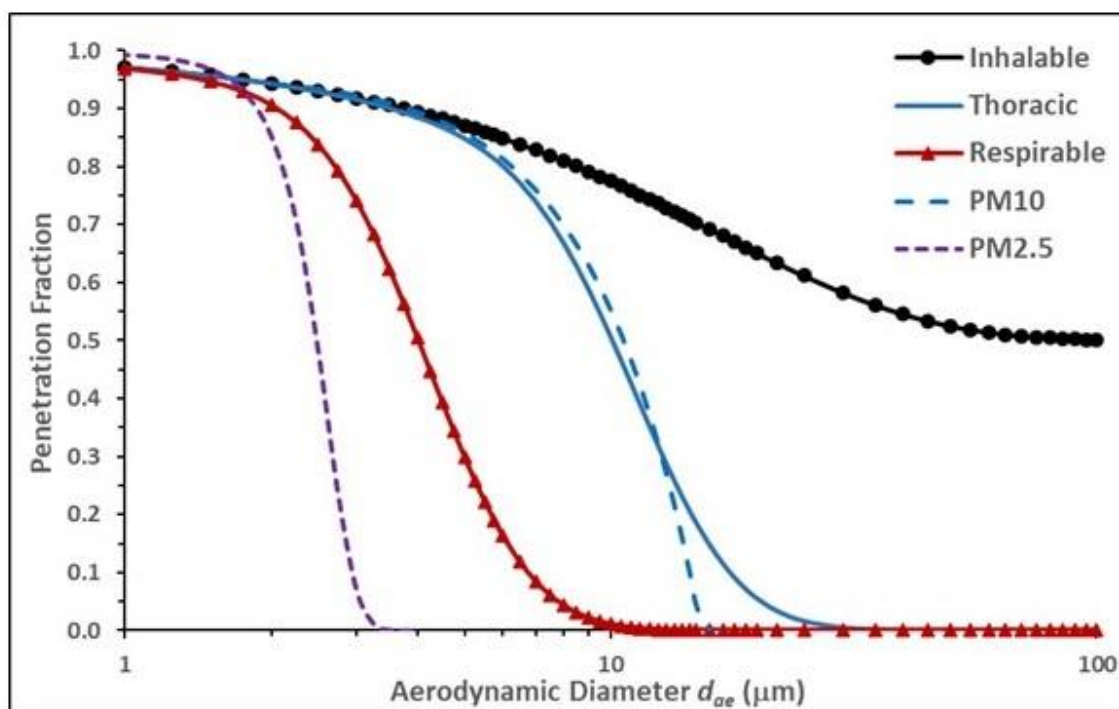

Figure 1. The inhalable, thoracic, respirable, PM10, and PM2.5 particle penetration curves [Hinds 1999; Vincent 2007].

Inhalation exposure is of particular concern when considering the potential health hazards of airborne dusts. Occupational lung disease has declined globally from 2000 through 2016, but inhalation exposure to silica, asbestos, and particulate matter are still responsible for more than 700,000 deaths and 16 million disability-adjusted life years in 2016 [WHO/ILO 2021]. Airborne particles may also enter the mouth (ingestion), the eyes (ocular), or deposit on the skin (dermal).



The adult human respiratory system offers about 70 square meters (m²) of surface area [Hasleton 1972]. By some estimates, the respiratory system is twice the surface area of the digestive system, thirty times the surface area of the skin, and arguably more susceptible to the outside environment [Combs and Dickson 2020]. Depending on size, chemical composition, morphology (shape), and concentration, dusts resulting from powders may be characterized as nuisance, irritant, toxic, or carcinogenic. In pharmaceutical manufacturing or dispensary environments, airborne dusts may be highly pharmacologically potent [Champmartin and Clerc 2014; Fent et al. 2014; Gold et al. 1973].

b. Relevance of airborne dusts to occupational safety

Airborne dust generation from a process, activity, or spill can result in an increased risk of slips and falls. Some materials can reduce the friction between a worker's footwear and that of the floor, stairs, ladders, for example. Powders that are used for their lubricant or glidant properties are particularly noteworthy, even in small quantities. Excessive dust generation (a nuisance dust, for example) can result in decreased visibility within the workplace, potentially causing other accidents. Materials that are electrically conducting can lead to electrical short circuiting [OSHA 2005]. Short circuiting can damage equipment or electrical infrastructure, and become a source of ignition, causing a fire [NFPA 2021, 2022].

Materials that are capable of being oxidized in air, themselves a potential fuel, can pose a fire and explosion risk. These materials are commonly referred to as combustible dusts and can be a considerable hazard within the workplace [NFPA 2019]. An ignition source, the powder (fuel), combined with oxygen in the air, may be capable of supporting combustion as a powder fire. By further dispersing the powder in air, either as part of a process or inadvertently, a sufficiently strong ignition source (hot surface, flame, spark, electrical arc, etc.) can result in a flash fire. When coupled with confinement, combustible dusts can lead to dust explosions [Cashdollar 2000; CSB 2006, 2018; Eckhoff 2003]. Confinement can result from containing process equipment, pneumatic conveyance systems, or dust control or collection systems. On a larger scale, it can be the walls of a structure or the entries within a mine.

These risks and their potential consequences are well documented in coal mining, manufacturing, agriculture, food processing, and other industrial environments. The reader is encouraged to seek expert guidance in analyzing the risks and adopting appropriate mitigation measures [CSB 2006, 2018; Eckhoff 2003; HSE 2003; NFPA 2019, 2020; OSHA 2005, 2020].

c. Economic considerations resulting from airborne dusts

During materials manufacturing and processing, potential loss of product or degradation in product quality creates a potential loss in revenue. Preventing or controlling dust emissions is therefore economically prudent. Where multiple product lines are situated close together, the potential exists for cross contamination of both equipment and product. Therefore, a decrease in product quality could occur with airborne dust from one source possibly contaminating another. Cross contamination may also have



consumer health or regulatory implications, particularly in food processing or pharmaceutical manufacturing [e.g., Gold et al. 1973]. Equipment contamination can lead to premature wearing and failure of critical moving parts. In addition, there are costs associated with dust cleanup (housekeeping).

One further aspect is using potentially costly engineering dust-controls. The system size, possibly amplifying the capital investment and operating costs, must be considered. Often, manufacturers desire a process, product, or intermediate that does not require the use of ventilation, dust capture, containment, or filtration systems, or perhaps requires scaled-down versions of these systems.

d. Factors influencing exposure

Many factors can influence whether workers will be exposed to aerosolized particles from powders and to what extent. Possible factors include the following:

- Type of operation or task (from low to high energy processes or activities, for example)
- Quantities of materials (mass or volume)
- Proximity of the worker to the emission source
- Ventilation in general (dilution)
- Presence of any engineered exposure controls (enclosures, local exhaust ventilation, etc.)
- Leaks in process equipment
- Worker technique with respect to manual handling scenarios
- Physical properties of the powders themselves

From an occupational or industrial hygiene perspective, when material flow is followed within the workplace, transfer points stand out as emission sources. These transfer points have the potential for elevating worker exposures. Examples might include removing lids, emptying containers or bags of feedstocks, scooping manually, weighing out, pouring, dumping, conveying, transferring from conveyor, stockpiling, reducing aggregate size, classifying size (e.g., sieving), bagging and packing of product, harvesting product from reactors, unmolding, maintaining systems, spilling accidents, cleaning equipment, disposing of bags, etc. [e.g., Cheng 1973; Dahm et al. 2012; Dennis and Bubenick 1983; Evans et al. 2008; Evans et al. 2010; Hammond 1980; Heitbrink et al. 1992; Heitbrink et al. 1989; HSE 2013; Lundgren 1986; NIOSH 2014a, 2018b; Petavratzi et al. 2007; Ribalta et al. 2019a; Sutter et al. 1982; Visser 1992].

Task-based, short-term, or direct-reading sampling [NIOSH 2021b] in these situations may be particularly useful for identifying and quantifying these exposure-prone activities. The use of video exposure monitoring (VEM), whereby video footage of tasks or operations are overlaid with aerosol concentration data from a direct reading instrument, can be used to identify key events that contribute to a worker's exposure [e.g., NIOSH 2014b]. VEM can also be a powerful tool in the subsequent training of workers [Rosén et al. 2005]. A fine dust cloud can be visualized directly and coupled with photography or video footage.



The “dust lamp” is another dust visualization tool that uses a strong, carefully positioned light to exploit the Tyndall effect, which is the scattering of light by particles [HSE 2015]. Exposure-prone activities, even for short durations (i.e., less than 15 minutes), can also be drivers of time-weighted exposure concentrations when averaged over an entire working shift of 8 to 10 hours.

e. Relating dustiness to inhalation exposure

The best available worker inhalation exposure information is through exposure assessment, where air sampling is conducted within the personal breathing zone of the worker [Vincent 2007]. This can be done on a short-term, task-based, or long-term (full shift) basis. However, where inhalation exposure information is incomplete, dustiness information may be used to fill knowledge gaps based on potential source strength (dust yield). For example, it may not be feasible to concurrently sample for all particle size fractions (inhalable, thoracic, and respirable) on a worker. Dustiness information could potentially be used in historical worker exposure reconstruction if existing exposure information was rudimentary, incomplete, or lacking.

Cowherd et al. [1989b] studied the dust emissions from 3.8 liter (L) (1-gallon) volumes of finely divided powders transferred to 23 L (6-gallon) containers within an experimental room. Test powders consisted of talc, sodium chloride, Portland cement, and a Direct Yellow 4 dyestuff. Emission factors, especially those at a 25-centimeter (cm) drop height, compared well with dustiness indices resulting from the Midwest Research Institute (MRI) dustiness test configuration described later (see Section 3.b.2). Emission factors for scooping and dumping were the same as the emission factors for pouring at a given drop height. Therefore, drop height was determined as an important experimental variable.

Heitbrink et al. [1989] found a significant correlation between dustiness tests and worker exposure during the bagging of powdered acrylic resins at an industrial facility. Investigators used the Heubach (Type I) rotating drum (see Section 3.c) and the MRI dustiness test configurations (see Section 3.b.2) to assess workers for total dust exposure. They noted that addressing material dustiness is important for predicting and controlling worker dust exposure.

In later work, Heitbrink et al. [1990] compared MRI test results with that of task-based worker exposure measurements (total dust) from four work sites while workers performed bag dumping, bag packing, or tank charging with acrylic resins, crystalline silica, titanium dioxide, talc, and lead chromate. Dust controls were described as “minimally effective.” At two of the sites, dustiness measurements provided the relative exposure potential of the materials used. However, at two other sites, an inconsistent relationship was found, presumably with other exposure factors playing a more significant role.

Brouwer et al. [2006] compared the dustiness of magnesium stearate, aluminum oxide, and calcium carbonate obtained in the EN15051-2 rotating drum [CEN 2013b] with operator exposures from semi-controlled dust-handling experiments within a room. Ventilation and environmental variables were controlled during scooping, weighing,



adding, and dry clean-up tasks (brushing, scooping, discarding waste) from both bench and floor surfaces. Dustiness was found to be the major exposure determinant, contributing to ~70% of the exposure variance. Furthermore, the ratios of respirable and inhalable fractions, as determined by dustiness tests, were comparable with the ratios observed for the exposure measurements. The results emphasized the relevance of dustiness as a parameter for exposure potential.

Ribalta et al. [2019b] found a high degree of correlation ($R^2 = 0.77\text{--}0.97$) between dustiness indices from the EN15051-2 rotating drum and EN15051-3 continuous drop test configurations [CEN 2013b,c] and inhalable exposure concentrations measured during high- and low-energy materials-handling experiments. Five ceramic test powders, which included silica sand, three quartz powders, and kaolin, were handled in 2-kg batches. Researchers suggested that dustiness could be considered a relevant predictor for workplace exposure.

Dustiness is a major determining factor in the concentration of worker inhalation exposures. Therefore, dustiness may be used to provide inhalation exposure estimates based on the quantities of materials used in the workplace. For example, considering the milligrams of dust generated per kilograms of material used or “dust yield.” Tests that provide the inhalable, thoracic, and respirable particle size fractions are best suited for this purpose. Particle size fractions of exposure need to be measured within the worker breathing zone and compared with that measured during dustiness testing if the relationship between exposure and dustiness is being investigated. Improved control of external variables (humidity, air flow, etc.) in the experimental design may result in a stronger relationship between dustiness and worker exposure when future dustiness-exposure studies are conducted. The relative anticipated ratios of the particle size fractions may also be estimated from dustiness experiments.

f. Controlling exposures through the hierarchy of controls

The first and most basic step in the control of hazards is recognizing them [WHO 1999]. Traditionally, a hierarchy of controls has been used as a way to implement feasible and effective controls [NIOSH 2023]. Following the hierarchy normally leads to implementing inherently safer systems, ones where the risk of illness or injury has been substantially reduced. In order from the most effective to the least effective control is elimination, substitution, engineering controls, administrative controls, and personal protective equipment.

Elimination would be an example of removing a hazard in its entirety from the workplace. This may be difficult to achieve if the hazardous product has unique and desirable physical properties that are required for the product/process. Substitution might be possible through replacing a hazardous product with one that was less hazardous or possibly the same material in a less hazardous form. For example, a form that produces much less airborne dust. Bakeries used this approach where they increased vegetable oil content from 2% to 4% within an improver mix. This reduced airborne dust allergen content and the potential for worker exposure by 77% [HSE 2010].

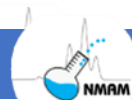

Engineering controls remove hazardous conditions (e.g., local exhaust ventilation that captures and removes airborne emissions) or place a barrier between the worker and the hazard (e.g., containment). Well-designed and implemented engineering controls can be highly effective in protecting workers. These actions should be passive, that is, independent of worker interactions [NIOSH 2014a]. Engineering controls should not hinder workers' productivity or make work more difficult to do. NIOSH provides strategies and guidance on applying engineering controls to the processes and downstream handling of nanoscale materials [NIOSH 2014a, 2018b]. These strategies may also apply to other industrial scenarios besides nanoscale manufacturing.

Administrative controls could involve training of employees, perhaps in applying techniques that generate less airborne dust. It may involve restricting access or limiting shifts to a dust-generating area or process to only those workers who need to be present. A last resort would be using personal protective equipment, such as a respirator [NIOSH 2018a], to address the potential for worker exposure.

In the United States, workers are required to be trained, fit-tested, and medically cleared for certain types of respirators as part of a formal Respiratory Protection Program (CFR 1910.134) [OSHA 1998]. Similar requirements can apply in other countries. For a comprehensive discussion of the use of ventilation, enclosures, and other approaches in controlling dust exposures, readers are encouraged to consult AICHE [2005], ACGIH [2020, 2023], and HSE [2013, 2017a, 2022]. For specific guidance and examples for mining or minerals processing, see the NIOSH *Dust Control Handbook* for industrial minerals mining and processing [NIOSH 2019] or the NIOSH *Best Practices for Dust Control in Coal Mining* [NIOSH 2021a]. For pharmaceutical containment, look to the International Society for Pharmaceutical Engineering [ISPE 2012] for good practice guidance.

g. Control banding

The traditional approach to protecting worker health is to measure worker exposures to potentially hazardous agents, compare them with occupational exposure limits (OELs), and then determine if existing control measures provide adequate protection [NIOSH 2009]. However, relying on this approach has become increasingly difficult due to the growing number of potentially hazardous materials in the workplace that do not have OELs [Garrod and Rajan-Sithamparanadarajah 2003]. The EPA reports that the Toxic Substances Control Act Chemical Substance Inventory contains over 86,000 chemical substances [EPA 2023], yet only about 1,000 chemical substances have been assigned at least one authoritative (government, consensus, or peer reviewed) OEL. In addition, small- and medium-sized enterprises may employ a large proportion of the workforce yet may not possess occupational safety and health expertise [HSE 2017b; Zalk and Nelson 2008].

Consequently, control banding (CB) strategies have been proposed to make engineering control decisions for general chemical substances without OELs or perhaps without expert guidance [NIOSH 2009; Zalk and Nelson 2008]. Typically, CB strategies consist of two main components: (1) hazard bands and (2) exposure (or emission potential)



bands. These qualitative bands rank substances based on their hazardous properties and their production/use, which range from low to high levels of hazard and/or exposure potential. The combination of the hazard and exposure bands is used to derive the exposure control band and associated engineering control options for a given task/process.

CB takes a pragmatic approach in that many previous worker-exposure problems have solutions, and only limited control options are generally applied in practice. Risks can therefore be grouped or banded. In ascending order, control measures could include, at a minimum, good industrial hygiene practice coupled with general ventilation (dilution), the use of fume hoods or local exhaust ventilation, containment, enclosure, isolation, and last, expert guidance [Brouwer 2012; Maynard 2007; Paik et al. 2008; Zalk and Nelson 2008].

Exposure or emission potential bands are qualitative descriptors of potential exposure levels, given the factors that may influence exposure such as dustiness, type of process or task performed, and the amount of material being handled (ISO 12901-2) [ISO 2014]. The standardized dustiness test configurations (i.e., continuous drop and rotating drum), described in EN15051 [CEN 2013a–c] and discussed later in Sections 3.b.2.A and 3.c.2, provide threshold dustiness values to which a tested product may be compared. Values can ultimately be designated for each of the health-based particle size fractions, such as very low, low, medium, or high dustiness (exposure potential). Those products with higher dustiness, and therefore exposure potential (depending on hazard), may require more stringent control measures. Dustiness values, as we will see later, may range by several orders of magnitude. A dustiness parameter, where available, is a useful input into CB tools. Further guidance on control banding may be found in NIOSH [2009], ISO [2014], and HSE [2017b].

h. How dustiness testing may be used

A major reason for work-related ill health and disease is airborne dust that results from the dustiness of a powder [Burdett et al. 2000]. Dustiness testing data may be used in a myriad of ways. In this chapter, we will not cover *all* ways in which data can be used. We will provide the reader with some perspective on the possibilities with respect to occupational safety and health. The strong correlations generally observed between dustiness and inhalation exposure, and which are used as an exposure potential input in control banding, are discussed in Sections 2.e and 2.g.

In product and process engineering, dustiness information may inform the development of less dusty products or forms of the same material. Efficacy of dust suppression additives, such as moisture or oil, for example, may inform a substitution control. Less dusty (reduced dustiness) products can greatly benefit downstream users. The selection of appropriate surrogate powders (e.g., lactose, mannitol, and naproxen sodium) for assessing exposure control performance in pharmaceutical manufacturing can be based off dustiness performance data of the active pharmaceutical ingredient (API) or formulations containing the API. The use of dustiness information (with reference to the method used) can be included with safety data in communicating hazards (health or



safety) to downstream users about the potential for dust generation through handling of a product. Data derived from experimental test systems, which emulate the dispersion characteristics of propagating coal dust explosions, may be used in selecting effective mitigating products [Perera et al. 2016].

The dustiness of a new or unknown powder may be compared with that of a more familiar powder. This could be done through laboratory dustiness tests of both powders and through workplace inhalation exposure measurements, typically conducted in the worker breathing zone. The effect on inhalation exposure measurements in the workplace may then be directly related back to the differences in powder properties. One may also compare a new or previously unknown powder to the threshold dustiness values included in EN15051-2 and EN15051-3 [CEN 2013b,c] (and see Sections 3.b.2.A and 3.c.2), if these test configurations are used. Dustiness comparisons can help identify improvements needed in manufacturing equipment design and exposure controls before the new powder goes into full scale production. These are examples of exposure prevention through design [ANSI/ASSP 2021].

A further use of dustiness test systems is to compare aerosol sampler or instrument performance [e.g., Dahm et al. 2019; Evans et al. 2010] from a well-mixed contaminant atmosphere or perhaps to further method development and validation [e.g., Baron et al. 2008; Neu-Baker et al. 2019]. In this application, dustiness test systems provide a realistic source of contaminant dust, one that might be encountered in the workplace, for example.

3 Dustiness test methods

a. Classification of methods

It is useful to classify the various dustiness test systems by the mechanism used to generate airborne dust. Lyons and Mark [1992] noted that one must consider the way dust is dispersed and sampled when designing a dustiness test method. A number of dustiness test configurations have been described in the past. When initially classifying different dust generation testing methods, BOHS and others categorized them into three main methods: gravity (drop methods), mechanical dispersion (including rotating drums in this case), and gas dispersion (aerated fluidization) [BOHS 1985; Chung and Burdett 1994].

The goal of all dustiness methods is to produce results that relate the mass of airborne dust produced to the mass of the original powder [Boundy et al. 2006; Burdett et al. 2000]. The more widely used examples are discussed here, however, readers can find less notable examples in other sources [e.g., BOHS 1985; Hamelmann and Schmidt 2003, 2004].

For a historic view, BOHS [1985] reviewed 18 dustiness test devices that existed at the time, and Hamelmann and Schmidt [2004] documented more than 65 devices. Over the intervening years, as of 2023, many more devices have been developed. In further sections, test configurations described are categorized into gravity-induced methods,



rotating methods (closely affiliated with gravity-induced methods), fluidization methods, and aerodynamic methods. These categories are used because they more appropriately describe the underlying material-dispersion processes.

b. Gravity-induced test configurations

A falling powder within the workplace is a very common mechanism of airborne dust generation, whether part of a materials transfer processes, activity, or an accidental spill. It is no coincidence that many historical dustiness test configurations are within this category. Falling powder test systems can use one of three different methods: a single drop type, where a powder sample is dropped as a single bolus and impacts with a solid surface; multiple drop types (such as rotating test configurations discussed in Section 3.c); or continuous falling types, where a continuous stream of powder winnows down a test chamber.

Some test configurations include the contribution from the powder impacting the solid surface, yet others do not [e.g., Heitbrink et al. 1992]. As noted by BOHS [1988], when comparing dustiness devices, continuous falling methods generally provide more consistent results than single drop methods. Although with notable exceptions, the majority of falling powder configurations have been of the single drop type.

1) Single drop configurations

An early test device to quantify dust release from coal and coke was developed in 1928 [Powell and Russell 1933]. This device was the first reported quantitative dustiness test configuration and used the single drop method. The investigators were motivated as dustless or low-dust domestic solid fuel products became commercialized. They realized that an empirical method was needed to quantify dust release so the effectiveness of dust suppression (laying) additives could be assessed.

A metallic dust-tight enclosure, which was 1,520-millimeters (mm) or 5-feet (ft) high and 457-mm or 18-inches (in) wide and deep, incorporated three horizontal slides and a 305-mm (12 in) deep drawer. A large upper slide inserted 305 mm (12 in) below the top of the cabinet formed the base of the initial test powder compartment. In here, a massive 25 kilogram (kg) or 55 pounds (lb) of the dried test sample was loaded. Two polished, passive settling slides (one situated above the other), inserted 610 mm (24 in) above the base of the sample receiving drawer, were used to collect the settled dust. The dried test powder was loaded with the upper sample compartment slide inserted, whereas the lower settling slides were initially withdrawn.

The test began by a rapid withdrawal of the upper slide, $t = 0$ second (s), allowing the 25-kg test sample to fall into the receiving drawer at the base of the enclosure. The resulting dust cloud, presumably generated during both the powder fall and the impact with the receiving drawer, was allowed to settle under gravity. At $t = 5$ s, the two settling slides were inserted into the enclosure. Following 2 minutes of settling ($t = 125$ s), the upper (coarse dust) sampling slide was withdrawn, and the lower (fine dust) slide remained. After another 8 minutes of settling ($t = 605$ s), the fine dust slide was withdrawn. The two dustiness indices (coarse dust and fine dust) were collected by



carefully brushing off and weighing the dust on the two slides. The results were reported in gram/ton of dust to fuel product.

ASTM D547-41 [1980], a test method for determining the dustiness of coal and coke, was directly derived from Powell and Russell [1933] above. The method, first standardized in 1939 (ASTM D547-39T), was revised in 1941 (ASTM D547-41), last reappraised in 1980, and finally withdrawn in 1986. Only minor changes were incorporated into the ASTM D547-41 [1980] test configuration over the earlier Powell and Russell [1933] device. The receiving drawer was enlarged to 356-mm (14 in) deep, minimum sheet metal gauges were suggested to ensure containment integrity, and an optional automated slide insertion was used. The test sample mass was standardized to 22.7 kg (50 lb), and samples could be tested either as received or dried over 1 to 3 days. Duplicate tests were anticipated to have a reproducibility of within 20% of the mean average. If this was not initially attained, additional testing was recommended.

The fine coal or coke dust was denoted as “float” dust. This long-established terminology [e.g., BoM 1927] continues today within mining environments to describe airborne coal dust particles that remain airborne and may be transported on air currents. These particles are defined as those with a diameter less than 75 μm or that pass through a U.S. 200-mesh sieve [NIOSH 2006].

There was also a scaled down version of ASTM D547-41 [1980]. It required a 200-g test sample, a pivoting hopper, and a fall of about 400 mm [BOHS 1985]. Active particle samplers were used to measure total dust and the thoracic particle size fraction (using a horizontal elutriator).

Andreasen et al. [1939] performed a classical study of the dust-generating capacity of 24 fine materials. Lycopodium powder (Lycopodium), which contains the spores from the Lycopodium clubmoss plant, were used as a reference material and assigned a dispersibility of 100. Twenty-three other test powders were then compared. The test system comprised a single drop of a 2-milliliter (mL) bolus of powder down a vertical chamber with a 145-mm diameter and 2500-mm height. Collection plates at the base of the apparatus were used to determine the quantity of dispersed dust by Stokes’ gravitational settling.

A European dyestuff industry consortium developed another single drop configuration called the Roaches Dust Particle Apparatus (Roaches Engineering Ltd., UK). It was reported in Berger-Schuun et al. [1989] and evaluated by Lyons and Mark [1992]. A single 10 g of test powder was dropped from an open funnel at a fall height of 800 mm. The powder went through a vertical enclosure and into a cylindrical and initially quiescent chamber. Here, the falling powder impacted with the base. Five seconds following the test sample drop, a pre-weighed filter positioned at the top of the collection chamber (200 mm above the base) started sampling the total dust for 2 minutes at 15 liter per minute (L/min).

Another single powder drop device, the Dustview II, developed by BASF and the University of Wuppertal (Wuppertal, Germany), is remarkably similar to the Roaches Dust Particle Apparatus configuration [Berger-Schuun et al. 1989]. The 30-g powder



sample was dropped 750 mm as a single bolus into a chamber where the resulting aerosol is optically monitored with an aerosol photometer. A combination of the initial dust cloud (maximum concentration) and dust concentration at 30 s provide for a dustiness number between 0 and 100.

Further inspired by the Dustview II configuration, O'Shaughnessy et al. [2012] described a single drop low-mass dustiness test system. The powder sample (15 mg) was dropped from a height of 610 mm within a metal tube with an inner diameter of 9.5 mm.

Substituting an aerosol photometer with an aerodynamic particle sizer, O'Shaughnessy et al. [2012] estimated the respirable aerosol fraction from the test powder.

A further single drop test configuration conforms to DIN 55992-2 [1999] and was briefly assessed by Burdett et al. [2000]. It consisted of a single drop column, required a 2-g dust sample, and used optical extinction to estimate the mass concentration of airborne dust. A sliding plate arrangement allowed for several repeat tests. An output of between 0 and 1 indicated the total dust light-extinction. As with any optically based method, a relationship between gravimetric mass and optically derived mass for a given test powder needs to be established.

Burdett et al. [2000] described a novel single/multiple drop test configuration. It used a test drop column above a stationary, cylindrical drum. In the drop configuration, a 600-mm high column held the test powder in a hopper with a trap door, in a similar arrangement to the Roaches test configuration previously described. As the experiment began, the test powder was allowed to fall the 600-mm length down the column, which was fixed atop a 300-mm diameter drum. An impaction plate 200 × 250 mm at the base of the drum received the falling test sample. A gentle cross flow of air (38 L/min) through the drum transported dust containing air to size-selective foam substrates. A final filter allowed for the health-based inhalable, thoracic, and respirable size fractions to be determined [ACGIH 1999; CEN 1993; ISO 1995]. In initial testing, the falling test powder splashed from the impaction plate to the collection foams, adding considerable variability between experiments. This phenomenon was directly observed by removing the drum inlet. Later tests incorporated an impaction plate lip to reduce the potential sideways splash of the test powder impact. Although this drop test configuration is not currently used, the drum received further development, as later discussed in Section 3.c.

A contemporary drop method, which measures dispersed powder, is the ASTM D6393 [2021] Carr dispersibility test. It is a single drop configuration described as one of several powder tests measured by the PT-X Powder Characteristics Tester. In this test, 10 g of test powder falls 170 mm unconfined. It then falls through a cylindrical tube with 100-mm diameter and 340-mm height. The test powder falls another 102 mm, unconfined, onto a pre-weighed concave watch glass (with 100-mm diameter). The total height of the powder fall is about 612 mm. The dispersed powder is the mass of the powder that does not deposit on the watch glass, i.e., is not recovered from the experiment. Dispersed powder is usually expressed as a percentage of the original mass (10 g) of the powder test sample. This test configuration is focused more on manufacturing product performance than from a worker health or a safety perspective.



The open nature of portions of the apparatus and the subsequent external loss of some fraction of the test powder may preclude the handling of some powders.

2) Pour or continuous drop configurations

A pour configuration was described by Wells and Alexander [1978] at Unilever (Sharnbrook, UK). This Unilever dust-yield test-configuration was notable as it was one of first to consider health-related particle size fractions. During the test, the 100 to 300 g test powder was loaded into a wide stainless-steel funnel with a 20-mm stem bore diameter and 20-mm length with a closed slide. The slide was opened, allowing the test sample to pour a height of about 310 mm into the sample chamber below (within a few seconds). Air drawn horizontally across the falling powder at 50 L/min entered a Hexlet elutriator and provided the respirable particle size fraction. A similar flow rate across the powder and with a simple filter arrangement provided for total dust in a repeat experiment.

To study fugitive dust emissions, a pouring device was described by Lundgren [1986] and Lundgren and Rangaraj [1986] at the University of Florida (Gainesville, FL, USA). The device simulated pouring and dumping of relatively coarse industrial aggregates, such as phosphate rock. The test was similar to the Powell and Russell [1933] and ASTM D547 [1980] devices, but it used active instead of passive sampling. Over a 1-min period, 5 kg of test material was poured down a 1,524-mm (5 ft) column into a rectangular test chamber. As the material fell down the column, air was sampled at 1.9 m³/min using a standard high-volume (Hi-Vol) sampling configuration located 914 mm (3 ft) above the chamber base.

Cowherd et al. [1989a] at the Midwest Research Institute (MRI; Kansas City, MO, USA) described the MRI pouring/drop device. The device had a powder drop height of 250 mm and fell onto a solid receiving surface. The MRI device was inspired by the earlier Lundgren [1986] configuration. A vibrating stainless-steel sample cup of 270 mL, filled with 250 g of test powder, was slowly rotated at 0.8 rotations per minute (rpm). This resulted in a more continuous stream of powder. The airborne generated dust was sampled from the top of the containment chamber with a 47-mm filter at 8.3 L/min for 10 minutes, resulting in about 4.2 air exchanges within the device.

A. EN15051-3 [CEN 2013c] continuous powder drop test

Falling powders are common mechanisms of dust generation within the workplace, whether intentional or unintentional. As noted earlier by BOHS [1988], continuous falling test methods generally provide more consistent results when compared with single drop test methods. The EN15051-3 continuous falling powder test derives from an early prototype [Burdett et al. 2000; Dahmann et al. 1997]. A former DIN method, DIN 33897-2 [2002], was withdrawn and superseded by EN15051 in 2006. A schematic is provided in Figure 2.

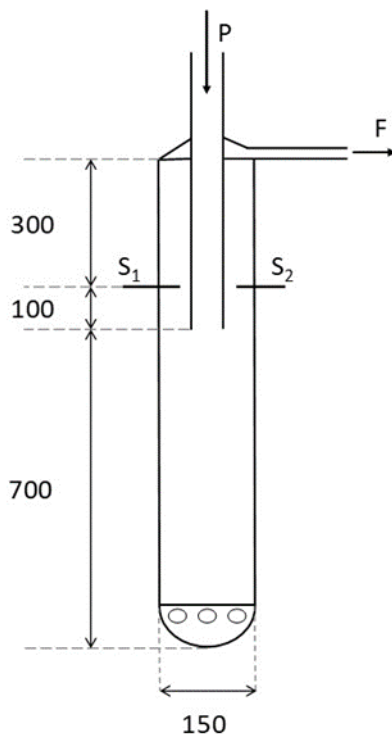

Figure 2: Schematic drawing of the EN15051-3 [CEN 2013c] continuous powder drop test configuration: continuous powder (P), main flow (F), inhalable sampler location (S1), and respirable sampler location (S2). Dimensions are in millimeters.

In the contemporary EN15051-3 [CEN 2013c] drop test, the powder is continuously fed at between (6 g/min to 10 g/min) by a metering device, such as a vibrating chute with adjustable feed-rate. The powder moves down a cylindrical feed tube of 400-mm length and 15-mm diameter within a larger backflow tube of 150-mm diameter. An earlier screw feed metering device could not deliver all test powder types, and in general, metering of the powder limits testing to dry powders [Burdett et al. 2000]. The powder falls a total height of 1,100 mm within the backflow tube, with the lower end of the feed tube positioned 700 mm above the base of the backflow tube and 400 mm below the top.

The experiment is performed against a slow countercurrent of upward moving air controlled at 0.05 m/s (53 L/min). A maximum particle size of about 38 μm can be carried by the upward countercurrent and be sampled [Burdett et al. 2000]. Test materials with a substantial particle fraction larger than 38 μm may result in a significant underestimation of the inhalable particle size fraction [Burdett et al. 2000]. The falling powder is collected into pre-weighed filter cups at the base of the apparatus. The falling powder is sampled by air samplers conforming to the inhalable (BIA GSP conical sampling head at 3.5 L/min) and respirable (BIA FSP cyclone sampling head at 2.0 L/min) size fractions. This occurs at a height of 300 mm below the top of the backflow chamber and 100 mm above the base of the feed tube, typically for about 10 minutes. The thoracic particle fraction is not quantified in this test configuration.



The mass collected by the inhalable and respirable samplers is then compared with the mass of powder delivered into the filter cup. A 500-g test sample mass is usually required for multiple tests to be performed (a minimum of four repeat tests).

Threshold values for the continuous drop method have been established from results of over 500 test samples (EN15051-3) [CEN 2013c]. The thresholds compare the amount of dust released (mg) to the parent powder fed into the test device (kg). For the inhalable fraction, less than 1,000 mg/kg is considered very low dustiness; between 1,000 and 4,000 mg/kg, low dustiness; between 4,000 and 10,000 mg/kg, moderate dustiness; and greater than 10,000 mg/kg, high dustiness. For the respirable size fraction, less than 20 mg/kg is very low dustiness; between 20 and 70 mg/kg, low dustiness; between 70 and 300 mg/kg, moderate dustiness; and greater than 300 mg/kg, high dustiness. These threshold values and their corresponding exposure potential bands for each of the particle size fractions (very low, low, medium, and high dustiness) allow for the exposure risk assessment of new and unknown powders.

EN15051-3 [CEN 2013c] has special application to certain workplace operations where the powder is poured a distance through air (perhaps 1 meter or more). Such operations might include the filling of containers or bags from a hopper, the filling of silos, or transferring powder from a conveyor, where the powder is permitted to fall continuously in a stream from a height. The EN15051-3 [CEN 2013c] continuous drop method has been further adopted for nanoscale materials and is described in EN17199-3 [CEN 2019c]. The dust generation portion of the test method remains unchanged, but different sampling arrangements may be employed.

c. Rotating test configurations

In rotating test configurations, a test powder is rotated within a cylindrical containment vessel fitted with internal lifters. As the substrate angle periodically increases, the test powder exceeds its angle of repose, and a local avalanche ensues; this aerosolizes a fraction of the falling test powder [Evans et al. 2013]. This multiple drop process repeats continuously throughout the test as the cylinder is rotated. A falling powder within the workplace is a common mechanism of airborne dust generation, as noted earlier.

Earlier classification of rotating, tumbling, or rolling drum/cylinder configurations considered the attrition (break up of larger particles or granules) aspect of these devices [BOHS 1985; Lyons and Mark 1994]. For example, in the first known description of a rotating test configuration [Cocke et al. 1978], attrition certainly contributed to the dust generation from agricultural grains. An attrition element may be present, particularly for larger materials such as grains, granules, or pellets, etc. However, the energy imparted to the test material that forms the airborne dust comes from the repeated fall of the material under gravity—where material is repeatedly scooped up by the internal protrusions, fins, lifters, or flights within the drum. So, we could say that rolling, tumbling, or rotating drum configurations are an important set of test configurations closely affiliated with gravity-induced falling powder methods, particularly those configurations operated at lower rotating speeds.



The finely divided solid, the internal surfaces of the drum, and air moving through the drum interact to generate and transport airborne dust. This dust moves out of the working dust-generation section to the sampling section for collection. Drum configurations more generally are capable of not only testing powders, but also flakes, granules, and pellets, or even larger forms of materials. For larger test materials, dust abraded or released from the surface is useful performance information. These larger forms are generally considered low-dust alternatives to fine powders.

Contemporary methods include the EN15051-2 rotating drum [CEN 2013b], discussed in later sections; the National Research Centre for the Working Environment (NRCWE, Copenhagen, Denmark) small rotating drum (Schneider and Jensen [2008] and EN17199-4 [CEN 2019]); Types I and II of the Heubach rotating drum (DIN 55992-1) [DIN 2006]; and an Australian coal dust device (AS 4156.6) [AS 2000]. All rotating test configurations tumble the same test powder continuously for the duration of the experiment. It is feasible that the particle size distribution of the dust released from the test powder may potentially change over time. This effect may be most marked over longer duration experiments.

The NRCWE drum [Schneider and Jensen 2008] includes aspects of both the Warren Spring Laboratory (WSL; Stevenage, Hertfordshire, UK) and later EN15051 [CEN 2013a-c] drum configurations, described in Section 3.c.2. A 6-g test sample mass is rotated within the NRCWE drum with 163-mm diameter, 5.93-L volume, and 20-mm diameter outlet. Three internal vanes, 20-mm deep, lift the test sample no more than 163-mm high at a rotation rate of 11 rpm for 1 minute. A 90-mm filter collects the generated dust and can be substituted for other particle samplers or by aerosol instruments (e.g., EN17199-4) [CEN 2019d].

Heubach drum configurations were originally developed in formulating dust-reduced pigments, potentially those containing toxic lead [Gawol and Adrian 1983]. Stauber and Beutel [1984] used a modified Heubach drum device to reduce the dusting potential of growth promoters in porcine feed premixes. Heubach drum configurations have seen considerable industrial use including chemicals, pharmaceuticals, food processing, and construction materials. The original Type I uses a dust-generating drum (140-mm diameter, 180-mm length, and three internal vanes) attached to a horizontal glass bottle as a sedimentation chamber, prior to collection on a filter cassette.

The Type II also employs the drum, glass sedimentation bottle, and filter cassette, but it is configured with the sedimentation bottle at an angle between horizontal and vertical, connected through an intermediate throat. The Type II configuration is typically used for dusty materials requiring greater sedimentation, as not to overload the filter. Rotation speeds can vary from 0 to 60 rpm and air flow rates from 0 to 40 L/min. These parameters are fixed and specified to conform to the DIN 55992-1 standard [DIN 2006]. One major drawback to Heubach Types I and II test configurations is that they do not provide for the health-based particle size fractions (inhalable, thoracic, and respirable).

The AS 4156.6 [2000] Australian Standard (AS) drum of 300-mm diameter was developed specifically for determining the dust and moisture relationship for coals. As moisture content of a coal increases, the dust-generating ability of the coal decreases



below the Dust Extinction Moisture (DEM) threshold, corresponding to a dust number of 10. The dust number is gravimetrically derived from the mass of dust collected within a filter bag to the initial test material of 1 kg. The AS 4156.6 [2000] standard was derived from the work of Farrugia et al. [1989]. The coal moisture content required to reduce coal dust generation below the DEM threshold is informative, as it can be applied to reduce dust hazards (health and safety) in transportation, transfer, and further processing of the coal. See Section 4.a on moisture content, humidity, and liquid additives. One possible shortcoming of this approach is that the moisture content of the coal may change over longer time periods, resulting in an increased ability to generate dust once the moisture is reduced.

Heubach and AS 4156.6 [2000] drum configurations operate at higher rotation rates (30 to 45 rpm, and 29 rpm, respectively) than the EN15051-2 and NRCWE versions (4 rpm and 11 rpm, respectively). At higher rotation speeds, air mixing, dust transport, and flow regimes appear to differ from configurations that operate at lower rotation speeds [Chen et al. 2021; Chen et al. 2023]. Drum configurations that convey inhalable, thoracic, and respirable particle size fraction information (e.g., EN15051 [CEN 2013]; EN17199 [CEN 2019a–e]), discussed in Sections 3.b.2.A and 3.c.2, are generally better suited to address worker inhalation exposure concerns. Those from worker health/worker exposure backgrounds may be more familiar with these devices. Test configurations that do not separate the airborne dust into the health-related size fractions can serve the needs of industry for product, process, and batch control, but provide limited information on the health hazards [Lyons and Mark 1992].

1) Evolution and development of the USDA, WSL, HSE, and CEN rotating tests

From the original U.S. Department of Agriculture (USDA) rolling device to the Comité de Européen Normalisation (CEN) rotating drum, this family of rotating test configurations received multiple iterative refinements in dust generation, particle sampling, and in general usability. The USDA rolling cylinder [Cocke et al. 1978] was refined by WSL for general material handling scenarios [Higman et al. 1984; Taylor 1984].

Several other investigators [e.g., Goodfellow and Smith 1988; Janhunan et al. 1988; O'Farrell and Vaughan 1986] used WSL drum configurations, but also suggested incremental improvements. The WSL rolling drum was selected as a promising method for further development [Lyons and Mark 1994]. Following a round-robin study by multiple laboratories [Lyons et al. 1996], the rotating drum was first adopted as a UK standard method (MDHS-81) [HSE 1996]. The rotating drum saw further development and refinement [Burdett et al. 2000] and, as a result, was subsequently adopted by CEN as one of two European dustiness methods described in EN15051 [CEN 2006]. The current EN15051-2 version [CEN 2013b] remains unchanged from the 2006 iteration. The EN15051-2 [CEN 2013b] rotating drum is arguably the most developed of the dustiness test configurations described in this guidance chapter, and one that has been most widely adopted worldwide.

An agricultural test device, described by Cocke et al. [1978] at the USDA (Clemson, SC, USA), consisted of a rolling cylinder, with a 430-mm (17 in) diameter and 680-mm (27 in) total length, that rotated on a hollow, fixed axle. Three internal angle-iron lifters



(dimensions not specified) lifted the test material as the cylinder rotated at 38 rpm. For a single test, 1.81 kg (~4 lb) of test material (wheat, soybean, and shelled corn grains) were used. Dust-suppressing oil of varying quantities was added as a spray. Following 2 minutes of rotation, the airborne dust within the upper section of the cylinder was actively sampled at 1.5 L/min for varying periods of further rotation (1–10 min), using a 37-mm, three-section (closed-face) cassette sampling for *total* dust. The cassette was positioned mid-length, with the inlet downward facing. An external vacuum pump, with flexible tube routed through the axle, provided the air flow. Grain (wheat) dust levels were reduced by more than 92% with an oil content of 0.07% [Cocke et al. 1978]. A dust-reduction approach using a mineral-oil additive was earlier applied to cotton textiles [Cocke et al. 1977].

Inspired by the earlier USDA rolling cylinder, the UK WSL established a rotating test system, among other tests, to study dust release, suppression, and prevention from a general material-handling perspective [Bransby 1977; Lyons and Mark 1994]. The 40-L WSL rolling drum configuration came with detachable conical ends, 110 mm in length, a dust generation section 460 mm in length, and a 300-mm diameter. It had a narrow 30-mm inlet and 20-mm exit [Higman et al. 1984; Taylor 1984] and eight equally spaced longitudinal internal lifting vanes (25-mm deep). The rolling drum sat upon two rollers, driven by an enclosed motor within the chassis, which rotated the drum assembly at 30 rpm. An air pump and flow control were housed within the lower chassis.

The chassis approach, with rollers, motor, pump, and flow control all housed below, was retained through the development of these rotating tests. The chassis remains in use with the current EN15051-2 standard [CEN 2013b]. The exit consisted of a rotating coupling, a pipe, and finally a static, modified, three-stage Anderson cascade impactor assembly with a 10- μm preselector, 9- μm impactor stage (coarse), and a final filter (< 9 μm , fine). The 10- μm preselector minimized overloading of the subsequent 9- μm impactor stage. A 100-g test sample was used. A flow rate of 23.8 L/min (1 ft³/min), the nominal flowrate required by the Andersen cascade impactor, passed through the drum transporting dust laden air to the impactor. The drum rotated initially for 5 seconds. The sampling flow commenced, and the drum continued rotation for the next minute. Three dustiness values were gravimetrically obtained: coarse (> 9 μm), fine (< 9 μm), and the sum of the coarse and fine fractions. The drum and collection substrates were cleaned. Two repeat experiments were further completed, for a total of three replicates.

In 1981, the BOHS Technical Committee and the UK Health and Safety Executive (HSE) established a longstanding goal in the selection, development, and standardization of a dustiness test method. Lyons and Mark [1994] selected the WSL rolling drum, from many test methods available in the early 1990s, as a candidate method for standardization. With a 300-mm dust generation diameter, the WSL drum was larger than the Heubach drum described in Section 3.c, providing flexibility in the type of materials that could be studied (e.g., powders, granules, pellets, lumps of materials, damp materials, etc.) Its construction was modular. It was the most versatile of dustiness test configurations, replicating dust generation by industrial rotating mixers, rotating feeders, or rotating conveyance systems. The WSL drum had been previously used to generate a large body of test material data for reference [Higman et al. 1984;



Lyons and Mark 1994]. The detachable end cones were very amenable to subsequent design changes.

Lyons and Mark [1992, 1994] suggested that the narrow 30-mm drum inlet and 20-mm exit potentially resulted in a central air jet forming. This air jet would not necessarily interact and mix sufficiently with dust generation toward the outer walls. Particle losses between the dust-generating section and the sampling section (within the pipe and a 90° radius in some setups) were thought to be significant, as well as the potential misclassification of dust because of impactor stage overloading for very dusty materials. Cleaning between experiments could often be laborious and time consuming.

Test powder initially positioned closest to the WSL drum exit was preferentially collected as airborne dust [Lyons and Mark 1994]. Quantitative measurements, with an aim of increasing the dust yield, favored a shorter drum length [Lyons et al. 1992]. The dust generation section length was shortened from 460 mm to 230 mm, which continues in the current EN15051-2 configuration [CEN 2013b]. Lyons and Mark [1994] also studied variables, such as test powder mass (25 to 400 g), air flow rate (20 to 40 L/min), and test run length (5 seconds to 4 minutes) to maximize the quantity of dust entering the sampling section at a drum rotation of 30 rpm. Following initial testing, an air flowrate of 40 L/min (initially), dust dispersion time of 1 minute, and a test mass loading of 200 g were further selected for the anticipated large range of materials that would ultimately be tested.

The sampling system required a significant redesign considering the newly defined (at that time) inhalable, thoracic, and respirable particle size fractions [CEN 1993; Chung and Burdett 1994; Lyons et al. 1992]. To achieve these particle size fractions, experiments were done to validate the use of porous polyester foams as particle size-selective collection media for the drum, based on long-established prior research and practice [Aitken et al. 1993; Brown 1980; Gibson and Vincent 1981; Roesler 1966; Whitby et al. 1961; Vincent et al. 1993].

Porous polyester foams of 30 pores per inch (ppi) and 90 ppi were selected; these were 25-mm thick and, nominally, 150-mm in diameter. Glass fiber filters of initially 70-mm diameter (prototype), and later 140-mm diameter (final version), were installed at both the inlet and dust collection ends of the drum. The central 130-mm diameter of the open foams collected the generated dust within a slightly larger (150 mm) aluminum carrying frame. A spacing insert placed between the drum and the first foam was found to have an insignificant effect on the resulting sampled dust. The flow rate through the drum was reduced slightly from 40 L/min to 38 L/min to provide a closer agreement between measured foam penetration to that of the thoracic and respirable particle size fractions within an acceptable 10% error. The 38 L/min flow rate remains in the current EN15051-2 standard [CEN 2013b].

Incidentally, and at least not initially by design, the combination of conical geometry and flow rate through the drum exit closely followed the inhalable particle size fraction. Lyons and Mark [1994] assessed particle penetration experimentally with sodium fluorescein and aloxite particles fed axially into the entry. Good agreement was observed with the inhalable size fraction for particles up to 30- μ m aerodynamic diameter. As



particle diameter further increased to 46 μm , particle penetration tailed off. Only those particles that were carried by the gentle lateral airflow and escaped the dust generation section could ultimately be quantified. The foams and filters rotated with the drum assembly. The foam and filter diameters made gravimetric weighing challenging. Only gravimetric balances (with four decimal places) capable of accommodating large media diameters could be used. Weighing/carrying frames held collection media in a vertical position during weighing.

For larger test sample masses (e.g., 200 g), there was some initial concern over the dust loading capacity of the porous foam media [Breum 2000]. Lyons and Mark [1994] reported that sample masses as high as 20 g could be reliably collected on porous foam media. With higher mass loadings, care in handling was needed to minimize dislodging collected material. A significant limitation was that polyester foams were subject to weight variations due to the uptake of atmospheric water vapor. Therefore, creating the need for two foam sets, one set in the entry to the drum (as controls) and another at the exit as collection media. An alternate method, using five sets of control foams set aside, was also feasible, but required many more gravimetric measurements to be made. The potential weight instability of the foams led to a measurement limit of about 6 mg on each foam, that is, dust loadings over 6 mg could conceivably be quantified. Lyons and Mark [1994] reported a range of dustiness values spread over five orders of magnitude was possible with the new prototype drum configuration, using 23 test materials from across different industrial sectors.

A round-robin study of the HSE/WSL prototype drum was eventually done by five laboratories using ten industrially relevant materials [Lyons et al. 1996]. A minimum four decimal place balance was stipulated. Results from low to high dustiness test materials spanned about four orders of magnitude (from ~ 1 to 10,000 mg). Respirable fractions below ~ 4 mg represented values below the test resolution limit. At least five dustiness measurements were recommended for each test material. A standardized version of the HSE/WSL drum was adopted as a UK method (MDHS-81) [HSE 1996].

The MDHS-81 [HSE 1996] rotating drum underwent further development and refinement by Burdett et al. [2000] and was recommended for further CEN technical workgroup consideration as a European standard. Much of the Burdett et al. [2000] study focused on optimizing the foam collection media and test variables that potentially influenced dustiness measurement. The adoption of metalized (nickel) porous foams largely mitigated the moisture (weight) variation issue of the earlier polyester foams. A control set of foams was no longer required, simplifying the configuration and the effort needed to perform a single test. Weighing weight-stable collection media improved precision and accuracy. This was particularly important for the quantification of low-dustiness materials. As a result of smaller foam diameters (150 mm reduced to 80 mm), a larger potential pool of analytical balances could be employed in the quantification of the collected dust.

Smaller foam diameters meant the drum had to have a smaller conical exit geometry, going from a 150-mm to 80-mm diameter. The 150-mm inlet and 80-mm exit remained in the current EN15051-2 standard [CEN 2013b]. The porosity (reduced from 30 to 20



ppi, and from 90 to 80 ppi) and dimensions of the foams (reduced from 150-mm to 80-mm diameter and from 25-mm deep, reduced to 20-mm and 12-mm deep) also changed to ensure the particle penetration of the foams continued to closely match the thoracic and respirable particle size fractions [CEN 1993]. The larger foam porosities (smaller ppi numbers) also improved dust loading capacities. The later nickel foams with 80-mm diameters (20-ppi and 20-mm deep; 80-ppi and 12-mm deep) are retained in the current EN15051-2 standard [CEN 2013b].

The latter 80-mm conical exit geometry was tested with four aloxite test dusts, fed axially into the drum entry at particle sizes up to about 60 μm [Burdett et al. 2000]. A generally good agreement with the inhalable particle size fraction was observed. An improvement was seen, particularly at larger particle sizes, over earlier iterations [Lyons and Mark 1994]. Standard conditions that further maximized dust release consisted of an electrically grounded (earthed) rotating drum, operated over a period of one minute, and used a low moisture content dust, at a relative humidity of 50% [Burdett et al. 2000]. These parameters were also further adopted. A summary of test variables for these rotating test configurations is provided in Table 1. Test configurations are typically fabricated from stainless steel.

Table 1. Parameters for notable, commonly used, or standardized rotating dustiness test configurations. Values in bold denote the most frequently used or standardized variable when several values were reported.

Drum	Drum Diameter (mm)	Drum Length (mm)	Vanes & Rotation Rate	Flow Rate (L/min)	Dust Collection Method	Test Powder Quantity	Test Duration
Cocke et al. [1978] USDA Agricultural Dust Cylinder	430	680	3 vanes, 38 rpm	1.5	37-mm three-piece (closed-face) cassette within upper cylinder	1,810 g	1 to 10 min
Heubach (DIN 55992-1) [DIN 2006]	140	180	3 vanes* 30 to 45 rpm	20	Settling chamber and filter	100 g	5 min
WSL Drum [Higman et al. 1984; Taylor 1984]	300 (30 inlet and 20 outlet)	460 with detachable 110-conical ends	8 vanes, 30 rpm	28.3 (1 cfm)	Stationary three-stage Anderson Impactor, 10 μm, 9 μm, and filter	100 g evenly along drum	1 min
Prototype WSL Drum [Lyons and Mark 1994]	300 (30 inlet and 20 outlet) initially then modified to 150 to accommodate foams at inlet and exit	460 Shortened to 230	8 internal vanes, 25-mm deep, 2-mm width, 30 rpm	20, 28.3, 35, 40, and 38	Three-stage Anderson impactor, then 150-mm diameter polyester foams (30 ppi and 90 ppi) and filter at inlet and outlet (130-	25 g, 100 g, 200 g , 400 g	5 s, 20 s, 1 min , 2 min, 4 min



Drum	Drum Diameter (mm)	Drum Length (mm)	Vanes & Rotation Rate	Flow Rate (L/min)	Dust Collection Method	Test Powder Quantity	Test Duration
					mm effective foam diameter)		
HSE MDHS 81 [1996] HSE/WSL drum	300 (150, foams, in carrier frames) and filters at both inlet and exit)	230	8 internal vanes, 30 rpm	38	150-mm diameter polyester foams (30 ppi and 90 ppi) and filter at inlet and outlet (130-mm effective diameter)	200 g	1 min
Burdett et al. [2000] modified HSE/WSL MkII drum	300 (150 inlet, 80 exit)	230	8 internal vanes, 25-mm deep, 4 rpm	38	Proposed nickel foams of 80-mm diameter with larger pores (20 ppi and 80 ppi) to negate overloading	Standard volume (35 mL) but also weighed	1 min
AS 4156.6 [AS 2000] Determination for dust moisture relationship for coal	300 (40 inlet, 40 exit)	300 with 100 conical exit	8 lifters, 7-mm wide and 6-mm deep, 29 rpm	170	Vacuum bag	1,000 g	10 min
Small-rotating drum NRCWE (Denmark) [Schneider and Jensen 2008]†	163, 20 exit, 5.93-L total volume	230 dust generation section, 63 conical ends	3 internal vanes, 20-mm deep, 11 rpm	11	90-mm filter plus aerosol instruments	6 (and 2) g	1 min
EN15051-2 [CEN 2013b]	300 (150 inlet, 80 exit)	230 dust generation section, 130-mm conical inlet, 80-mm conical exit	8 vanes 25-mm deep, 2-mm width, 4 rpm	38	80-mm diameter, nickel foam (20 ppi and 80 ppi) and filter (60-mm effective diameter)	35 mL weighed	1 min

*Internal vanes do not point radially toward the center of the drum, as in most other drum test configurations. †The NRCWE (Denmark) small rotating drum is the only configuration to specify internally polished surfaces (450+/-50 gloss units). In the EN17199-4 Standard [CEN 2019d], the inner surfaces of the small rotating drum are polished to a mean roughness profile of 0.19 µm, which may be obtained by vibratory polishing.

2) The CEN [2013] EN15051-2 rotating drum

The contemporary EN15051-2 [CEN 2013b] drum is arguably one of the most widely used test methods worldwide for determining the dustiness of bulk powders. It has been



employed to quantitatively assess a large range of industrially relevant test materials, as well as those commercially used. As noted in the previous section, the test configuration received significant attention by multiple laboratories while being developed, resulting in several iterative performance and usability improvements. The EN15051-2 drum has been adopted globally by many research institutions and is used routinely within industry and commercial laboratories.

A falling material height of less than 300 mm within the drum closely approximates gentle to moderate manual (seated or standing) benchtop procedures involving powders within the workplace. These procedures might include scooping, weighing, transferring, and preparing powder subsamples for quality control, for example. The drum also approximates well the dust generated from using industrial mixers and bulk rotational conveyance methods.

The apparatus consists of a stainless-steel drum with a 300-mm internal diameter on a lower rotating roller assembly with pump and air flow control. The drum is electrically bonded and grounded to the equipment electrical power supply. The ultimate fall height of less than 300 mm is influenced by the angle of repose for the powder (an indication of how cohesively the powder behaves). This determines how far the powder travels into the upper portion of the drum before cascading down under gravity. The pre-weighed test powder (35 mL) is loaded evenly along the base of the dust-generating section of the drum, prior to final assembly of the 150-mm inlet with filter. The drum rotates at 4 rpm for a total 1-min test cycle. Air is drawn through the drum at 38 L/min for the entire test period, passing through the 150-mm diameter inlet filter, the 300-mm diameter dust generation section, and, finally, the 80-mm diameter dust sampling system. A schematic of the rotating drum is shown in Figure 3. Within the dust generation section, a winnowing air current with a mean velocity of 0.9 centimeter per second (cm/s) is generated [Burdett et al. 2000]. The Reynolds number for the air flow within the central dust generation section of the drum is $Re \sim 570$ and indicates the flow is gentle and laminar [Chen et al. 2021]. The Reynolds number at the drum inlet is $Re \sim 1140$ and at the exit is $Re \sim 2140$ [Chen et al. 2021].

The sampling section of the drum is next to the dust generation section. It consists of two porous, metallic (nickel) foams (20-ppi or 800 ppm, 20-mm depth; and 80-ppi or 3,200 ppm, 12-mm depth). The 80-mm diameter foams are followed by an 80-mm diameter quartz-fiber final filter. The conical geometry that transitions between the dust generation section of the drum to the sampling section of the drum, at the 38 L/min flow, provides for the inhalable particle size fraction. The two foams and filter in the sampling section are each separated by 2-mm thick annular gaskets, with 80-mm outer diameter and 60-mm inner diameter. The effective sampling area of the foams and filter used for dust collection is therefore the central 60-mm portion. The combined weight change of the metallic foams and the quartz filter provides the inhalable, thoracic, and respirable particle size fractions simultaneously from a single experiment. A minimum of three replicate experiments are usually performed. If the relative standard deviations of the results are not within 10%, further replicates may be required. Results are typically expressed in mg/kg for each of the particle size fractions. Dustiness values for materials tested within the drum can span about four orders of magnitude [e.g., Chung

and Burdett 1994; Lyons et al. 1996]. Potential suppliers of the rotating drum apparatus are included in the EN15051-2 standard [CEN 2013b].

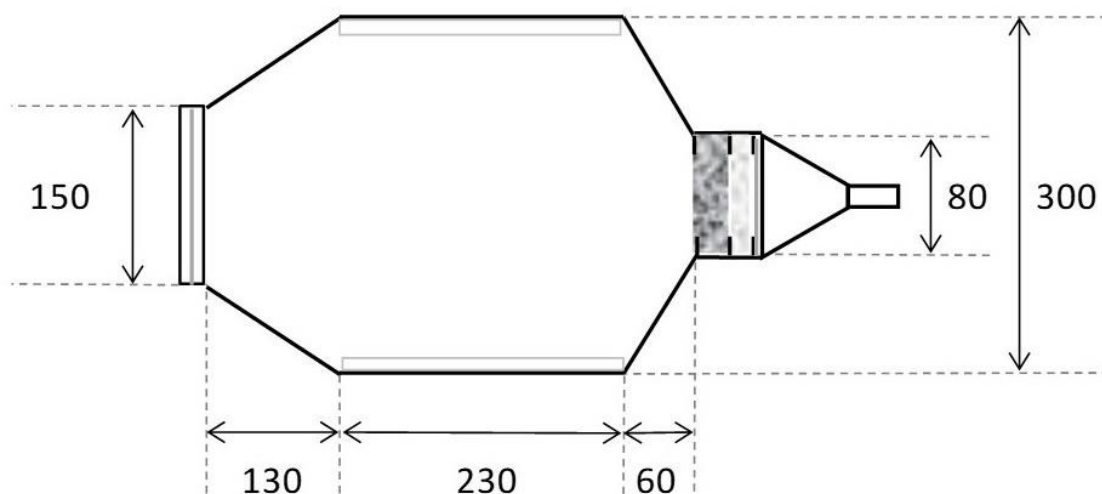

Figure 3. Schematic of the CEN [2013b] EN15051-2 rotating drum with dimensions in millimeters. Air flow at 38 L/min enters from the 150-mm filtered inlet (left) and goes through the 300-mm diameter dust generation section. It then enters the 80-mm dust collection section (right), consisting of three annular gaskets, two porous foams, and a final quartz filter.

Figure 4 shows a photograph of the porous cylindrical foams and filter. The air flow finally passes through a radial rotating union to flexible tubing, a pump, and flow controller. The whole drum assembly sits upon a chassis and is rotated by two external rollers (not shown) at 4 rpm.

A minimum five decimal place analytical balance (i.e., from 1-g, readability to 0.01 mg) is required for quantifying the dusts collected on the size-selective foams and filter (EN15051-2) [CEN 2013b]. Clean metallic foams typically weigh ~40 to 60 g. Clean 80-mm quartz-fiber filters typically weigh 270 to 285 mg. The draft shield of the analytical balance needs to be large enough to hold the 80-mm filter without the filter contacting the walls. An analytical balance with a minimum resolution of 0.1 g is required for weighing the 35-mL bulk test samples (EN15051-2) [CEN 2013b].

The EN15051-2 [CEN 2013b] drum has been used in characterizing nanoscale materials in EN17199-2 [CEN 2019b]. Gravimetric measurements are first performed by following EN15051-2 [CEN 2013b] and provide for the conventional inhalable, thoracic, and respirable dustiness fractions reported in mg/kg. In the EN17199-2 [2019b] configuration, the two porous foams and filter are replaced with an annular spacer (80-mm outer diameter and 60-mm inner diameter). An axial rotating union replaces the more typical radial rotating union that connects the drum to the system flow control and vacuum pump. The spacer and axial union allow for further external measurements to be made by aerosol instruments. The tubing needs to be kept short and sharp bends

should be avoided to minimize particle transport losses. The total flow through the drum needs to be maintained at 38 L/min.

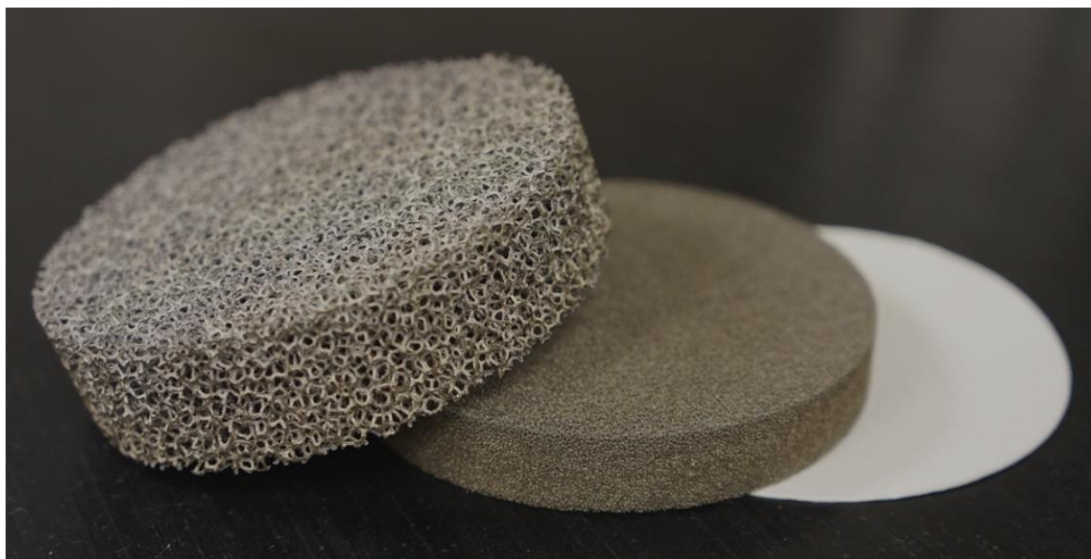

Figure 4. The two porous nickel foams (20 ppi top left and 80 ppi middle) and final quartz filter (base) used to collect the generated dust within the rotating drum (photo provided by D.E. Evans, NIOSH). The foams and filter have 80-mm diameters. The sample collection media are typically separated by 2-mm thick annular gaskets (80-mm outer diameter and 60-mm inner diameter, not shown).

Threshold values for the rotating drum method have been established from over 220 test samples (EN15051-2) [CEN 2013b]. The thresholds are based on the amount of dust released (mg) compared with the parent powder initially added to the test device (kg). For the inhalable fraction, less than 300 mg/kg is considered very low dustiness; between 300 and 650 mg/kg, low dustiness; between 650 and 3,000 mg/kg, moderate dustiness; and greater than 3,000 mg/kg, high dustiness. For the thoracic fraction, less than 80 mg/kg is considered very low dustiness; between 80 and 300 mg/kg, low dustiness; between 300 and 1,000 mg/kg, moderate dustiness; and greater than 1,000 mg/kg, high dustiness. For the respirable size fraction, less than 10 mg/kg is very low dustiness; between 10 and 60 mg/kg, low dustiness; between 60 and 210 mg/kg, moderate dustiness; and greater than 210 mg/kg, high dustiness. These threshold values and their corresponding exposure potential bands for each of the particle size fractions (very low, low, medium, and high dustiness) allow for the exposure risk assessment of new and unknown powders.

Burdett et al. [2000] noted that surface adhesion was an important test system variable, yet a polish or roughness value was not later specified in the EN15051 [CEN 2006] or later [CEN 2013a–c] standards. In contrast, the Schneider and Jensen [2008] NRCWE small rotating drum specified a surface polish or roughness value of 450+/-50 gloss units. In the EN17199-4 standard [CEN 2019d], the inner surfaces of the small rotating



drum are polished to a mean roughness profile of 0.19 μm , which as noted, may be obtained by vibratory finishing.

The coupling of the test powder, the internal surfaces of the test apparatus, and the cross airflow are important aspects of all rotating drum dustiness test configurations. The internal surface plays a larger role in drum test configurations than in others, such as falling powders. Intuitively, the roughness of the inner surfaces within the drum may influence wall adherence of the powder; but how much of that powder takes part in the experiment and what particles can escape the drum and be quantified. Different manufacturers of the standard test equipment may source different construction materials, so the internal surface roughness or polish quality may vary. We anticipate that a more polished finish would likely reduce inner wall adherence and maximize dust generation. Conducting multiple experiments in a series may help negate wall-adherence, with test material from the first experiment potentially pre-coating the internal surfaces. In practice, between experiments of the same powder, the excess powder is removed, but the internal surfaces may remain coated.

d. Fluidized test configurations

Fluidization may result in some fraction of powdered test materials being entrained within air. Fluidized methods may be further grouped into aerated or aero-fluidization and vibrating or vibro-fluidization. Fluidized methods are generally limited to dry test materials [Burdett et al. 2000]. Broßell et al. [2019] provide a summary of different fluidization modes for further reading.

Schofield et al. [1979] at WSL described an aero-fluidized device consisting of a vertical glass tube, 2,050-mm long with 70-mm inner diameter, and a porous base where a 400-g test sample was placed. The sample, consisting of no less than 10% test material (40 g) and no more than 90% (360 g) 350–500 μm sand, was *pulvated* (fluidized) by air at a 71 L/min flow rate through the medium. This was a two-component test sample and test configuration. A proportion of the aerosol was drawn iso-kinetically into an Andersen cascade impactor (size range $\sim 1\text{--}10\ \mu\text{m}$). The remainder of the aerosol was vented to the atmosphere. Dust was collected over a 1-min sampling period. The dustability (dustiness) of the test sample was determined as a cumulative emission rate in mg/min of “fines.”

An additional method was ASTM D4331-84 [1984], withdrawn in 1988, that assessed the effectiveness of dedusting agents mixed with powdered chemicals. ASTM D4331 could be classified as a combined aero- and vibro-fluidized testing configuration. A vertical, butyrate-plastic tube, with a 73-mm (2 7/8 in) internal diameter and 457-mm (18 in) height, acted as the vibrating housing where an initial 200-g test sample was placed. A pneumatic vibrating device, operating at 29 kilohertz, was clamped to the housing. An aeration flow of 15 L/min provided a face velocity of 6 cm/s up through the tube. Fluidized powder was applied from a polyester fabric-covered base. The vibrating housing prevented defined air channels from forming within the test powder column. A fraction of the dust-laden air was collected on a two-piece (open-face) 37-mm filter cassette for 20 minutes. Excess dust-laden air was vented to the atmosphere through an



optional 73-mm filter. The gravimetric mass of material collected on the filter provided the dustiness measurement.

Both fluidized methods described above suffered from electrostatic charge buildup, with particles adhering to the glass and butyrate walls of the devices [Cowherd et al. 1989a]. Fluidized methods are known for triboelectrification within the powder bed, and these charges subsequently carried on aerosolized particles. A further fluidized test configuration [Sethi and Schneider 1996] was assessed by Burdett et al. [2000] but not considered for further standardization.

The BOHS Technology Committee Working Party on Dustiness Estimation [BOHS 1985] reviewed six aerated or aero-fluidizing (gas dispersion) methods, including the WSL fluidized method [Schofield et al. 1979]; however, they did not recommend a fluidized method as practical for dustiness standardization. A primary factor was limited relevance to workplace operations that would result in worker exposures [BOHS 1985]. All fluidized methods agitate the same test powder sample over and over. The particle size distribution of the dust liberated from the test sample at the beginning of the test may differ from that liberated toward the end. The longer the test duration, the more marked this difference may be.

Contemporary fluidizer-based dustiness methods include the EN17199-5 [2013e] vortex shaker and a vibro-fluidization method specifically developed for dispersing fibrous materials [Broßell et al. 2019]. Vibro-fluidization contributes to aerosol generation in both test configurations. In the Broßell et al. [2019] combined aero- and vibro-fluidizer device, an upright aluminum sample tube (with 25-mm inner diameter, tapering to 16 mm at the top) was oscillated vertically at frequencies between 10 and 60 Hz and amplitudes between 0.05 and 1.5 mm. An air flow between 0.1 to 1.0 L/min was passed up through the vibrating powder column. A 300-mg test sample mass sat on a stainless-steel mesh at the base of the column. A variety of aerosol sampling and collection configurations could be connected to the device through a small (0.5 L) mixing chamber. A 75-min sampling time was noted. One of the major drivers for developing this device was the fiber analysis and counting according to the WHO phase-contrast method [WHO 1997].

1) **Vortex shaker**

The vortex shaker was first described as an approach to qualitatively aerosolize and study the properties of airborne single-walled carbon-nanotube particles [Maynard et al. 2004]. The device released particles from a 100-mg bulk powder sample. This work was conducted in parallel with some of the first reported nanomanufacturing workplace studies, also described by Maynard et al. [2004]. An initial attempt to use a conventional two-component fluidized aerosol generator, with the air flow fluidizing the medium (aero fluidization), was insufficient in aerosolizing the test powder for further analysis.

A more aggressive agitation with the vortex shaker (vibro-fluidization) was then attempted in both single- and two-component configurations. In the two-component mode, an aerosol contribution from the 70- μm bronze beads was detected. As further remarked by Maynard et al. [2004], "...it should not be assumed that the laboratory-



based method of aerosol generation provides a definitive characterization of workplace-related processes.” The authors recognized potential limitations with the vortex shaker approach.

Relevance to the workplace is a cornerstone of dustiness test methods from a worker inhalation exposure perspective. The close match between workplace operations or activities to dustiness test methods has historically been well understood [e.g., BOHS 1985; Lidén et al. 2006; Lyons and Mark 1992]. A subtle but very important distinction exists between laboratory aerosol generation techniques and quantitative dustiness test methods: the latter being those test configurations that tell us something about the test powder from a workplace health or safety perspective [e.g., Boundy et al. 2006; Evans et al. 2013; Lidén 2006].

In the EN17199-5 [CEN 2019e] approach, a small volume (0.5 mL) of the test powder is held within a vertical tube (31-mm internal diameter and 110-mm length) with a conical base. The test sample tube is vigorously shaken in an orbital motion (4-mm amplitude and 1,850 rpm at the base). An airflow (4.2 L/min) is introduced at the top fixed portion of the vertical tube and directed toward the powder sample with a smaller internal tube. The air does not pass *through* the test powder column as in aero-fluidization configurations. A small fraction of the fluidized particles from the top of the powder sample is transported by the airflow that ultimately exits in the opposite direction to the inflow. The vortex shaker is coupled to a cyclone to provide the respirable aerosol fraction. Ku et al. [2013] reported that small configuration or operational changes can have a potentially sizeable effect on the aerosol output from the vortex shaker. Ku et al. [2013] also reported the temporal evolution of the particle-size distribution of the aerosol generated by this method. This implies significant kinetic redistribution within the heterogeneous powder. While these effects are not completely understood, they underscore the challenges with this approach.

e. Aerodynamic test configurations

Aerodynamic dust dispersal mechanisms are observed in nature (i.e., Aeolian processes) [e.g., Bagnold 1941; Cowherd 1981; Gillette et al. 1974; Visser 1992]. These are highly relevant to the workplace, though perhaps not encountered as often as the gravity-induced mechanical dispersion experienced by falling powders. Aerodynamic dispersion involves the movement of air over a powder, in contrast to the movement of powder through air (mechanical dispersion). Aerodynamic dust dispersion can be differentiated from air moving through a test powder column (such as aero fluidization discussed earlier or gas dispersion described by [BOHS 1985]). Airborne dust generation and subsequent worker inhalation exposure from certain industrial processes or activities might be better simulated by aerodynamic dustiness test configurations.

Pneumatic conveyance systems (where air flow is used to transfer powders or other bulk solids within enclosed equipment) are common industrial transfer applications that have been available since the late 1960s [Bransby 1977]. Though not initially in powder form, another aerodynamic process example involves the removal of surface-grown or adhered products from substrates with a focused air jet. Products may then be collected



as a fine powder downstream for further processing. Using an air jet or air knife to clean contamination from a surface, or for drying or cooling manufactured parts, is also an aerodynamic process. A resulting aerosol is a finely divided solid suspended within the airflow.

The uncontrolled cleaning of contaminated clothing, surfaces, or process equipment using compressed air, although not recommended either from an exposure or safety perspective, is nevertheless observed in the workplace [Evans et al. 2013]. The closing and cinching of bags during product filling, and the removal of air from bags prior to disposal [e.g., Evans et al. 2010; Hammond 1980], can also be responsible for aerodynamic airborne dust generation. In general, these are vigorous dispersal mechanisms where moving air imparts kinetic energy to the powder. The underlying dust dispersion mechanism is by aerodynamic shear, consistent with a steep air velocity gradient. The result is typically highly turbulent air flows characterized by high Reynolds numbers. The aerodynamic reentrainment and dispersion of combustible dust from surfaces are responsible for the transmission of dust explosions [e.g., Cashdollar 2000; Eckhoff 2003; Perera et al. 2016].

An overview of aerodynamic dispersion mechanisms and available approaches for aerodynamically dispersing powders is provided by Calvert et al. [2009]. One of the underlying aerodynamic phenomena common to many dispersal devices is the Venturi effect. The Venturi effect is a reduction in fluid (air) pressure, resulting from a constriction within a pipe or tube. This reduced pressure region can be used to draw powder, aerosol, liquids, or other materials, and introduce them into a fast-moving airflow. The acceleration (or deceleration) of powder particles within the airflow provides enough aerodynamic shear to break up agglomerates that are held together by the relatively weak interactive forces (such as van der Waals). Multiple commercial dust/aerosol generators rely on the Venturi principle to combine powders/dusts and rapid air flows into airborne dusts/aerosols.

1) UNC Venturi

Boundy et al. [2006] at the University of North Carolina (UNC; Chapel Hill, NC, USA) introduced a novel dustiness testing device for pharmaceutical application. It allowed small (mg) quantities of pharmacologically active powder to be safely dispersed within a fully enclosed device. The device used a small stainless-steel funnel/nozzle arrangement where 5 mg of a test powder sample was initially placed. Figure 5 shows the nozzle with the lid removed. When activated, the device dispersed the test powder sample (under reduced pressure) into a 5.7-L glass chamber. In the chamber, metallic versions of two common industrial hygiene samplers (37-mm closed-face Slaton cassette and BGI GK2.69 cyclone fitted with a 37-mm filter cassette) were placed to sample the resulting dispersed dust.



Figure 5. The UNC Venturi dispersion nozzle with lid removed (photo provided by D.E. Evans, NIOSH). The nozzle is fabricated from stainless steel. The O-ring seal for the lid (removed) is visible at the funnel. The length of the nozzle (from left to right) is 72 mm. The left portion of the nozzle is inserted into the glass containment chamber through a rubber grommet.

Closed-face and opened-face 37-mm cassette configurations performed comparably for five test powders [Boundy et al. 2005]. The closed-face configuration was chosen for improved sample integrity. Both metallic samplers were electrically bonded to the metallic chamber lid and the lid electrically grounded to the power supply. Figure 6 shows the two samplers fixed to the underside of the containment chamber lid. A microbalance of at least 6 decimal places (i.e., 1 μg readability from 1 g) is recommended for quantifying the collected airborne dust on the polytetrafluorethylene (PTFE) or PVC 37-mm diameter filters [Boundy et al. 2005; Evans et al. 2013]. See the later section (Section 4.d) on gravimetric weighing.

A single dustiness test involved two consecutive 5-mg dispersions for a total of 10 mg of dispersed test powder. This increased the quantity of material ultimately collected, improving sensitivity twofold. For each dispersion, the sampling period lasted 4 minutes and the dispersion phase lasted 1.5 s. The 4-minute sampling period provided for more than four air exchanges within the chamber: an air exchange approach similar to Cowherd et al. [1989b]. The aerosol samplers provided for total aerosol, approximating the inhalable size fraction [Dahm et al. 2019] and respirable aerosol [Kenny and Gussman 1997] at flow rates of 2.0 L/min and 4.2 L/min, respectively. As with many other dustiness devices, the mass collected on the filters (determined gravimetrically) was compared with the initial mass of the test material. Due to the narrow geometry within the Venturi nozzle, in practice, this dustiness method applies to testing powders

and small granules only. Flakes and pellets are not suitable as with many other test configurations.



Figure 6. Metallic aerosol samplers attached to the underside of the UNC Venturi containment chamber lid (photo provided by D.E. Evans, NIOSH). The respirable GK2.69 cyclone sampler is on the left and the total dust closed-face Slaton cassette is on the right. Both samplers are in contact with the center grounding clip.

Motivated by the need to disperse small (less than 1 g) quantities for expensive, difficult to obtain, or toxic test powders, Evans et al. [2013] applied the UNC Venturi to 27 fine- and nanoscale-powdered test materials. Authors reported results that spanned about two orders of magnitude for both total and respirable dustiness. They also observed an exponential particle concentration decay following dispersion of the test sample within the containment chamber. Within the ISO [2021] TS 12025 technical specification, this test configuration is described as a dynamic method of the release and measurement of nano objects from powders.

The UNC device is more commonly referred to as the Venturi method, as it is best understood that the Venturi effect is used in both drawing and aspirating the test powder into the containment chamber [Evans et al. 2013; Evans et al. 2014]. Aerodynamic shear within the nozzle, and for some cohesive test powders, perhaps into the containment chamber, appear to be the underlying mechanisms by which the powder is dispersed. Numerical or computational fluid dynamic modeling of the sampling chamber with airflows and particle trajectories (1- μm aerodynamic diameter) has also been studied once injected from the nozzle [Dubey et al. 2017].



The airflow, at the point of exiting the nozzle and entering the chamber, is highly turbulent and characterized by a Reynolds number of $Re \sim 20,000$ [Dubey et al. 2017]. Test powder aerosolization within the dispersion nozzle is only partially understood [Palakurthi et al. 2017, 2022; Sharma et al. 2020a,b]. The UNC device appears to be robust to inhomogeneous test powder injection or injection being delayed. The test powder is also well mixed at the conclusion of the injection phase: an important consideration when sampling from within the chamber.

The Venturi method offers an energetic and efficient powder dispersal, making best use of small (mg) quantities of available test powder. It has been used to disperse many carbon nanotube and carbon nanofiber test samples [Bishop et al. 2017; Dahm et al. 2019; Fraser et al. 2020]. Particularly when minimizing test powder quantities and generating less waste (a substitution exposure control) are desired and good laboratory practice. The method has been described as possibly representing a worst-case exposure scenario [Evans et al. 2013]. Therefore, when exposure controls are selected to mitigate potential exposures through dustiness information gained from the Venturi dustiness configuration, they are likely to be the most protective and capable of mitigating the full spectrum of worker exposure scenarios, from gentle handling through to worst-case energetic dispersals. Materials with a greater dustiness, and therefore exposure potential, may require more stringent exposure controls. Several Venturi dustiness testing devices are located at research institutes and pharmaceutical manufacturing sites worldwide.

2) Rock dust dispersion chamber

Coal dust explosions are a serious safety hazard in underground coal mines [Cashdollar 2000]. Rock (stone) dusting in coal mines goes back over 100 years in the United States [BoM 1927]. The practice originated in the United Kingdom and France following multiple mining disasters and prevents propagating coal-dust explosions. Unlike most occupational dust release scenarios, an increase in the relative dispersibility of rock dust is beneficial because only rock dusts that disperse and become airborne can effectively mitigate the risks from combustible coal dust. An incombustible content of 80% or more is required when mixed with coal dust to prevent propagating coal dust explosions [NIOSH 2010]. An aerodynamic test configuration was developed to quantify the dispersion of pulverized rock dusts. Perera et al. [2016] describe the device, which uses a carefully controlled pulse of compressed air (40 psi, 276 kPa, 2.76 bar) through a narrow (1.4-mm internal diameter or nominal 1/8 in) nozzle, placed upstream at the upper surface of the test sample tray. During the 0.3 s air pulse, a channel of rock dust is scoured from the upper test sample surface. The mass of initial test sample may range from ~45 to 260 g (directly related to the bulk density of the test dust) within the constant volume (225 mL) sample tray. The resulting airborne dust cloud is carried downstream at 1.5 m/s within a 152 × 152 mm (6 × 6 in) × 1,524 mm (5 ft) length containment chamber, where it is detected optically. Figure 7 shows the rock dust dispersion chamber with a more detailed view of the test sample tray and nozzle arrangement in Figure 8. The loss of test powder from the tray and the relative optical density (obscuration) measured downstream within the chamber quantifies how effectively the rock dust is dispersed in each experiment.

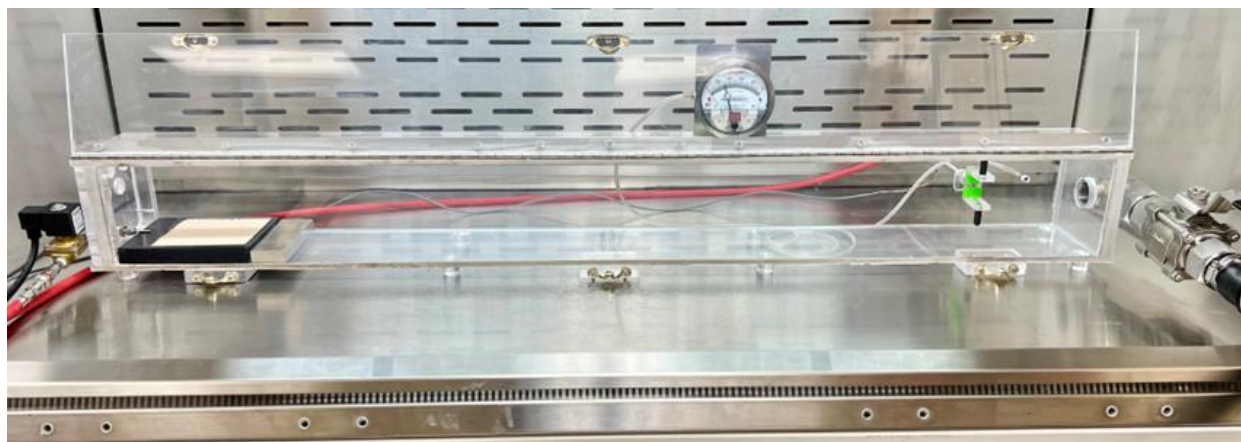

Figure 7. The rock dust dispersion chamber (photo provided by D.E. Evans, NIOSH). The transparent acrylic containment chamber is 1,524 mm (5 ft) in length. The chamber sits within a nominal ~1,800 mm (6 ft) width laminar-flow ventilation hood for easier cleaning between experiments. The dust sample tray and nozzle are to the left and the optical detection probe, pressure monitoring port, and flow control valve are to the right. The front hinged lid of the chamber is opened for clarity. The lid is closed during an experiment.

Water in underground mining can cake rock dust, making dispersion much less effective. Coal dust retains some dispersibility when wet. Rock dusts with anti-caking properties have therefore been developed to address this problem [Perera et al. 2016].



Figure 8. Dispersion nozzle, test sample tray (pre-loaded with mineral dust), and ballast weight to prevent the tray shifting during an experiment (photo provided by D.E. Evans, NIOSH). A series of five holes in the chamber, situated above the nozzle, introduce laboratory air for dust transport. The front hinged lid of the chamber is opened for clarity. The dust sample tray is 190 mm long.



4 Key considerations for dustiness

There are test powder measurements that typically accompany dustiness testing (moisture content and bulk unconsolidated density determinations) and are required according to EN15051-1 [CEN 2013a]. Moisture content (or the presence of other liquids) is perhaps the most important variable in the release of dust from powders, both within the workplace and during testing. There are important considerations for taking representative test samples from a bulk powder and in the gravimetric weighing of test powders and dust collection media when quantifying dustiness. Finally, we discuss further factors that may influence dust release in the workplace and through laboratory dustiness testing. Though these factors may influence some powders, i.e., are material specific, they often exhibit a complex relationship with dustiness and so are not reliable predictors in dustiness behavior. The role of multiple interparticle forces acting within a bulk powder is extremely complex [e.g., Castellanos 2005; Munroe 2020].

a. Moisture content, humidity, and liquid additives

One of the more widely recognized variables influencing dustiness is moisture content [e.g., Burdett et al. 2000; Farrugia et al. 1989; Levin et al. 2015; López-Lilao et al. 2017b; Plinke et al. 1995; Pujara 1997; Visser 1992]. Burdett et al. [2000] described moisture content as the most important variable in dustiness testing, potentially capable of producing order-of-magnitude variations. In the workplace, aqueous slurries or pastes are simple, low-dust alternatives to dry powders. These could conceivably be considered a substitution exposure control (see Controlling Exposures in Section 2.f) if slurries or pastes are amenable to downstream manufacturing processes. Oils, or other liquid additives, might also be considered in reducing dust generation [e.g., Cocke et al 1977, 1978; HSE 2010]. Water or oils can potentially reduce the dustiness of a powder by increasing interparticle or interagglomerate capillary adhesion. At the microscopic level, the formation of menisci or bridging between particles occurs, although the behavior is exceedingly complex [e.g., Cleaver and Tyrrell 2004; Rabinovich et al. 2002].

Low moisture content for powders, perhaps coupled with low ambient humidity, can potentially cause problems with electrical charge accumulation and static electricity. This, in turn, can make the handling and transfer of materials considerably more challenging [Bailey 1984]. The dissipation of charge within dustiness test systems can also influence dustiness by a factor of two [Burdett et al. 2000]. So it is generally best practice that quantitative test systems be electrically grounded. Moisture content of the powder and the accumulation of electrical charge can at times be interrelated [Visser 1976].



The moisture content history of the powder may also influence dustiness. If a soluble or partially soluble component is present, water vapor may be adsorbed, forming solutions at higher humidities. Even if the powder is returned to a reduced relative-humidity environment (and moisture content), solute bridges at interparticle contact points may persist [Plinke et al. 1995], significantly influencing powder properties and dustiness. In one extreme example, fine granulated sugar (sucrose), when subjected to 50% or greater relative humidity, deliquesced, forming a liquid solution [Evans et al. 2013]. Once dried, a single solid pellet remained, and fine sugar granules were not recoverable.

Powders can cake and sometimes plug equipment as their humidity or moisture content increases. This is a well-known problem in process engineering, bulk solids handling, and bulk powder conveying and storing [AIChE 2005]. The caking of rock dusts caused by moisture, which are used to mitigate potentially explosive coal dusts in underground mining operations, can render rock dusts ineffective [Perera et al. 2016].

The effect on powders of water uptake or loss to the ambient atmosphere, therefore, has implications for both workplace risk assessment and for laboratory testing. In the first instance, worker exposure concentrations during powder processing and handling could be influenced by season (dry winters, humid summers, for example), that is, if powders are permitted to equilibrate their moisture content with the atmosphere. If permitted, humid summers may decrease the dust-generating potential of some powdered products. Conversely, drier winters might also result in an increase in the dust-generating potential. In the laboratory, quantitative dustiness testing is significantly impacted by powder moisture content. For example, using the NRCWE small rotating drum and the same TiO₂ test powder, dustiness decreased by three orders of magnitude (1000x) with a relative humidity increase from 30% to 50% during the preconditioning of test powders [Levin et al. 2015]. This underlines the importance of careful control of this variable.

1) Determining moisture content

There are generally two acceptable approaches in accounting for the moisture content of test powders. The first approach is the testing of powders *as received*: the moisture content of the test sample is determined and reported together with the dustiness information. This approach is currently recommended in EN15051-1 [CEN 2013a, Annex A], and the dustiness experiment conducted at $50 \pm 10\%$ relative humidity (RH). It may be useful to determine the dustiness of a powder *as produced* or perhaps as an intermediate product within a multistep manufacturing process. Commercial testing laboratories routinely use the *as received* approach.

A second approach, and the one adopted more recently in EN17199 [CEN 2019a–e], is the careful preconditioning of the test powder at $50 \pm 5\%$ RH. Note that in this latter standard, the acceptable humidity range under which materials may be preconditioned and dispersion experiments performed is more carefully controlled (i.e., $50 \pm 5\%$ RH versus $50 \pm 10\%$ RH). The preconditioning period could span several hours to 48 hours, depending on the size of the test powder sample. Generally, larger sample sizes require longer equilibration periods. For tight control of humidity (and ambient temperature), the test apparatus may need to be modified to supply acceptable conditioned air while

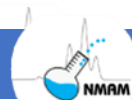

testing. This is required if ambient laboratory conditions do not meet test requirements. It can be achieved by supplying excess conditioned air to the test apparatus, for example, through an antechamber arrangement or similar [Evans et al. 2013].

Determining the moisture content of test powder may be done in at least two ways. One of the simplest is the oven-dry method. For this, about 10 g of pre-weighed powder (as received or conditioned) are heated in an oven at 120°C for several hours or overnight (EN17199-1) [CEN 2019a]. The powder is briefly allowed to cool before post-weighing. Best practice is cooling the powder within a desiccator containing an active desiccant. The mass loss is reported as the moisture content (typically in %).

When both as received and conditioned moisture content are required, three sequential gravimetric measurements can provide this information efficiently, particularly if test sample quantities are scarce. In this approach, between 1 and 10 g of the as received powder are pre-weighed (into a small glass petri dish or similar). This powder sample may be conditioned ($50 \pm 5\%$ RH, $21 \pm 3^\circ\text{C}$) for at least several hours. The sample is then re-weighed. The sample can then be heated within the oven at 120°C overnight, briefly allowed to cool (within a desiccator, if available), and then post-weighed. Thus, the moisture content as received and conditioned at 50% RH may be deduced by subtracting the final oven-dried mass. Clean, dry petri dishes can also be conditioned in parallel to the test samples (and pre- and post-weighed) to provide for substrate control. In addition to the oven method, using a dedicated moisture analysis instrument is also acceptable (EN15051-1) [CEN 2013a].

b. Bulk density

A test material parameter commonly reported with dustiness information is the bulk density (EN15051-1) [CEN 2013a, Annex B]. More specifically, this is the *unconsolidated* or *untapped* bulk density of the test powder. In the EN15051-1 [CEN 2013a] standard, 10 g of test powder are gently placed into a volumetric cylinder, and the volume is recorded. Only very light tapping or knocking is acceptable in filling the cylinder, as further compression or consolidation of the test powder can erroneously influence the density measurement. A minimum of three separate determinations are typically made, and the mean average reported. If dustiness measurements are made by the EN15051-2 rotating drum [CEN 2013b], the required 35 mL of test powder is pre-weighed within a volumetric vessel before carefully loading into the drum. If the vessel is further post-weighed, not only is the mass of the test material loaded in the dustiness experiment determined, but also the untapped bulk density (density = mass/volume). Each rotating drum dustiness experiment will provide an independent bulk density determination, and no further measurements are required.

c. Representative powder samples

During testing it is important to take a representative test sample from a larger bulk powder. During transport, it is possible for particles to partially segregate within the bulk powder, particularly with a wide mix of particle sizes. Consider the Brazil nut effect where we often find the larger Brazil nuts migrate toward the top of a container of mixed nuts [Gajjar et al. 2021]. A similar process occurs for heterogeneous powder



samples. Powder taken from the top of the sample may not possess the same size distribution as that at the base, or even be representative of the powder sample taken as a whole.

To counter this effect, some approaches, such as using rotary sample dividers or rifflers, or quartering the test material, can be done. Such approaches are often used when sending out test materials from a much larger master batch for interlaboratory comparisons [e.g., Lyons et al. 1996; Pensis et al. 2010; Totaro et al. 2016]. A simple method described in EN15051-1 [CEN 2013a] is inverting the bulk powder sample several times before taking a subsample from the top of the powder column. This should be done just before a subsample is removed for testing and ensures adequate mixing of the test powder. General guidance on sample preparation for powders can be found in ISO 14488 [2007].

d. Gravimetric weighing

Dustiness test configurations typically rely on the gravimetric measurement of airborne dust on collection substrates and may be directly compared with the quantity of the original test material (e.g., g/ton, %, mg/kg, etc.). Irrespective of balance type, manufacturer, or model, good weighing practices need to be followed when quantifying the initial test material and the collected airborne dust. In general, balances are set up according to manufacturer specifications. A balance should be situated in a low draft environment and on a heavy weighing table, to minimize movement and vibrations. A draft shield, if supplied with the instrument, should be used.

While using a balance, a stable temperature ($21 \pm 3^\circ\text{C}$) and RH ($50 \pm 5\%$) are recommended (e.g., EN17199) [CEN 2019a–e]. Test powders and collection media (filters or foams) may need to be adequately conditioned prior to weighing. Depending on application, a balance with a readability from three to seven decimal places (from 1 g) may be required (i.e., 1 mg to 0.1 μg readability). Masses ranging from milligrams to tens of kilograms may need to be quantified. Two (or more) balances may be required to cover an exceptionally large range of values. Electrostatic effects can be minimized by using static dissipative devices (ionizers). Standardized weights and media blanks should be used to regularly assess that the balance is operating correctly, to ensure there is no drift, and to provide confidence in weighing results. There are several sources of information on good weighing practices and minimizing the uncertainties in weighing [e.g., ACS 2021; EURAMET 2015; ISO 2009; Mettler-Toledo 2015].

e. Compression

The compression of powders may be intentional or perhaps a consequence of processing, conveyance, or storage. For example, compressing formulations into tablets can provide effective, low-dust, and convenient forms of pharmaceuticals for storage, transport, and dispensing to consumers [e.g., Davies 1992]. Tableting, pelletizing, or granulating products could be considered a substitution exposure control (see Controlling Exposures, Section 2.f) if these forms are amenable to downstream use. Like moisture-induced effects, the physical effects resulting from powder compression may



not be completely reversible once the powder load is removed. This suggests that powder compression history is an important factor in testing.

The storage of powders in industrial bulk quantities can generate compression loads on the powder. Levin et al. [2015], for example, reported 160 kilogram per square meter (kg/m^2) corresponded to a pressure experienced at the base of a single European pallet holding of five layers of bagged product. In the same study, Levin et al. [2015] subjected five nanoscale test powders to $160 \text{ kg}/\text{m}^2$ uniaxial pressure, followed by dustiness testing in the NRCWE small rotating drum [Schneider and Jensen, 2008]. Compaction increased, decreased, or had no effect on dustiness depending on the test powder, so the results were highly material specific. Much smaller changes in dustiness were observed than those by moisture content [Levin et al. 2015]. Following low pressure compaction ($3.5 \text{ kg}/\text{cm}^2$), a granulated organoclay increased in dustiness whereas the dustiness of a loose bentonite was reduced [Jensen et al. 2009]. These effects are material specific.

f. Surface modifications and coating

Using the EN15051-2 rotating drum [CEN 2013b], Burdett et al. [2013] observed that when nanoscale calcium carbonate powders were surface coated, dustiness increased 45 times for the inhalable, 90 times for the thoracic, and 331 times for the respirable dustiness fractions. Although organic (carbon containing) additives, the coatings were not specified. Perera et al. [2016] noted an increase in dustiness (quantified by airborne optical extinction) of treated limestone dusts when compared with untreated examples. A 1% (by mass) coating of calcium stearate was sufficient in generating about a fourfold increase in dustiness of the treated dusts when compared with their parent limestone constituents [Perera et al. 2016].

As noted previously, surface-treated limestone dusts are more effective in mitigating propagating coal dust explosions in wet, underground mining environments. Polymer coatings added to multiwalled carbon nanotube powders resulted in both observed increases and decreases in the dustiness measured by the UNC Venturi device [Bishop et al. 2017]. Authors observed a tenfold decrease and elevenfold increase in total dustiness and a corresponding elevenfold decrease and fivefold increase for the respirable dustiness fractions. This suggests a more complex and material specific relationship between dustiness and surface coating.

g. Particle size

In their study of powders, Plinke et al. [1995] assessed four parent test materials: limestone, TiO_2 , glass beads, and lactose. These were further classified into three aerodynamic size fractions prior to testing: less than $5 \mu\text{m}$, between 5 and $25 \mu\text{m}$, and greater than $25 \mu\text{m}$. Other factors, such as powder cohesion and impaction (height) during powder dispersion, were found to play a more prominent role in dustiness behavior than particle size for these four materials [Plinke et al. 1995].

Primary particle size, indicated through BET specific surface area measurements [Brunauer et al. 1938; ISO 2022], did not correlate with either total or respirable dustiness measured with the UNC Venturi for 27 fine and nanoscale powders [Evans et



al. 2013]. Counter intuitively, smaller particles do not necessarily result in increased dustiness. Respirable dustiness made up about one third of the total dustiness for the fine and nanoscale powders studied, but this relationship is not expected to hold for coarse test materials [Evans et al. 2013]. Given a sufficiently energetic aerodynamic stimulus (such as provided by the UNC Venturi), many of the nanoscale test powders tested could exhibit a relatively high respirable content.

López-Lilao et al. [2017a] studied 20 commercial materials (all minerals), including quartzes, feldspars, nephelines, carbonates, dolomites, sands, zircons, and alumina, with particle sizes collectively ranging from about 1 to 300 μm . Authors did not initially observe a clear relationship between mean particle size (d_{50}) and dustiness as measured by the continuous drop method (EN15051-3) [CEN 2013c]. However, when the inhalable and respirable dustiness results were compared with the relative emission potential of the parent mineral, a stronger relationship was observed between dustiness and particle size. Particle size of the parent powder may influence dustiness and the particle size fractions observed in the resulting airborne dust, but there is not a consistent relationship.

5 Criteria for current, improved, or new dustiness test configurations

What constitutes a *good* quantitative dustiness test configuration from the variety of tests described here is worth considering. This consideration may apply to current test configurations, to improvements or redesigns of existing tests, or to the development of new quantitative dustiness test methods. From a workplace inhalation exposure perspective, the tests may incorporate most, if not all, of the following attributes:

1. Direct relevance to workplace inhalation exposure scenarios.
2. Enclosed during operation for the health and safety of the technician.
3. Direct gravimetric determination of the health-based particle size fractions: inhalable, thoracic, and respirable [ACGIH 1999; CEN 1993; ISO 1995].
4. Particle transport losses between dust generation and collection either eliminated or minimized. If particle losses do occur, it should be shown that losses closely result in the particle health size fractions stated above.
5. Discriminate test materials over a wide dustiness range (i.e., orders of magnitude).
6. Ideally quantifies a range of test material forms (powders, granules, pellets, damp samples, etc.).
7. Well characterized.
8. Threshold dustiness values or exposure potential bands (i.e., very low, low, medium, and high dustiness, for example) are established for the comparison of new or unknown test powders.

Of the various contemporary test configurations discussed in this chapter, the EN15051-2 rotating drum [CEN 2013b] meets all these criteria from an inhalation exposure perspective. Most of these attributes may apply to other (non-inhalation exposure) test



configurations, including dust dispersion systems designed for studying the mitigation of dust explosion transmission.

6 Summary

The propensity with which a powder/dust becomes airborne is a major contributing factor in worker inhalation exposures [Brouwer et al. 2006; Heitbrink et al. 1989; Ribalta et al. 2019b] and can result in work-related illness and disease [Burdett et al. 2000]. This attribute may be defined by the term *dustiness*, and although not an intrinsic powder or dust property, is quantifiable, repeatable, and may be assessed independently of the workplace by well-prescribed test configurations [Evans et al. 2013]. Once airborne, powders and dusts may also pose significant safety hazards [Cashdollar 2000; Eckhoff 2003].

Quantifying the dustiness of powders and dusts can contribute to closing exposure-knowledge gaps. This would help in estimating the approximate airborne concentrations of worker inhalation exposures and improving understanding of the nature of those exposures. Testing potentially provides information on the particle size fractions that may be generated from an inhalation exposure perspective. This can help in selecting appropriate exposure or safety mitigation measures (control banding) and developing reduced or non-dust producing alternative products. The efficacy of dust reducing additives may also be assessed. Product packaging could then provide information warning potential employers and employees, particularly those who infrequently handle products, of possible hazards, so mitigation measures (controls) may be adopted.

Quantitative test configurations that provide the three health-based particle size fractions (inhalable, thoracic, and respirable) are preferred, particularly when considering worker inhalation exposures. Dustiness test configurations that possess dust generation mechanisms with direct relevance to the workplace, i.e., gravity-induced falling powders through air, and perhaps aerodynamic based methods, where air moves over the test powder, provide for more realistic exposure characteristics and exposure scenarios.

Results from new or unknown test powders may be compared with threshold dustiness values. In this way, we can determine the exposure potential (*very low*, *low*, *medium*, and *high* dustiness) that new test powders may have for each of the three health-based particle size fractions [CEN 2013]. Exposure mitigation (controls) selection can be based on these exposure potential categories. Both test configurations described in EN-15051 [CEN 2013a,b] provide these thresholds; the rotating drum (EN15051-2) [CEN 2013b] provides all three size fractions, and the continuous drop (EN15051-3) [CEN 2013c] offers two of the three. It is recommended that potential users choose the test method that best simulates their materials and handling processes as stipulated in EN15051-1 [CEN 2013a].

The rotating drum test system (EN15051-2) [CEN 2013b] received substantial development and improvements in both performance and usability (see Section 3.c.2). It is the most widely adopted test method worldwide and closely replicates the dust generation mechanisms from moderate to gentle benchtop manual transfer/handling,



rotational mixers, or rotational bulk conveyance. Powder is permitted to fall no more than 30 cm (12 in). This test configuration also meets all criteria (Section 5) for current, improved, or new quantitative dustiness tests. The rotating drum may also be used to characterize nanoscale test powders as described by both EN15051-2 [CEN 2013b] and EN17199-2 [CEN 2019b]. Each experiment requires 35 mL of test powder, and experiments are conducted in replicate.

To simulate the continuous pouring of powder from a height (more than 1 m for example), the EN15051-3 continuous drop test [CEN 2013c] is an effective test system. Nanoscale materials may be characterized using the same dust generation configuration, but with other particle sampling options (EN17199-3) [CEN 2019c]. This test configuration does not incorporate the thoracic aerosol fraction. Further, not all test materials may be continuously fed with the powder feed mechanism, limiting test materials mostly to fine dry powders. The test may also underestimate the inhalable particle size fraction for test materials with a substantial fraction of particles greater than $\sim 38 \mu\text{m}$ [Burdett et al. 2000]. About 100-g of test powder is required per experiment, and experiments are conducted in replicate.

One possible shortcoming to the rotating drum, continuous drop test, and several other test systems described here are the quantities of test material required for testing. Experiments are typically repeated in replicate to assess variability. These quantities can be problematic when test materials are in limited quantities, cost prohibitive, or potentially toxic. The EN15051-2 [CEN 2013b] rotating drum and EN15051-3 [CEN 2013c] continuous drop are relatively gentle dust-generating test configurations. They may underestimate airborne particle concentrations and their size fractions from more energetic dispersion processes observed in the workplace. A complimentary aerodynamic technique, such as the Venturi, may provide for a better simulation of more vigorous (worst case) dust-dispersion processes and requires orders of magnitude less test material (10 mg per experiment).

Disclaimers: Mention of any product or company name does not constitute endorsement by NIOSH. Citations to external websites do not constitute NIOSH endorsement of the sponsoring organizations or their programs or products. NIOSH is not responsible for the content of these websites. Web addresses referenced in this document were accessible at the time of publication.

Suggested Citation: NIOSH [2024]. Quantification of airborne dusts from powders. Chapter AD. By Evans DE. In: Andrews RN, ed. NIOSH manual of analytical methods. 5th ed. Cincinnati, OH: U.S. Department of Health and Human Services, Centers for Disease Control and Prevention, National Institute for Occupational Safety and Health, DHHS (NIOSH) Publication No. 2014-151, <https://www.cdc.gov/niosh/nmam/>.

7 Acknowledgements

Kevin H. Dunn (NIOSH/DFSE), Leonid A. Turkevich (NIOSH/DFSE), M. Christina Kander (NIOSH/DSI), David Mark (HSE, UK, Retired), David Leith (Professor Emeritus, University of North Carolina), and Patrick O'Shaughnessy (Professor, University of Iowa) reviewed this NMAM guidance chapter. The author appreciates their many helpful

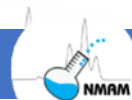

suggestions. The author is grateful for the longstanding support provided by the NIOSH Nanotechnology and Emerging Technologies programs.

8 References

ACGIH [1999]. Particle size-selective sampling for particulate air contaminants. By Vincent JH, Baron P, Hinds WC, John W, Lidén G, Lippmann M, McCawley MA, Phalen RF, Ratney RS, Stuart BO. Cincinnati OH: American Conference of Government Industrial Hygienists.

ACGIH [2020]. Industrial ventilation: a manual of recommended practice for operation and maintenance. 2nd ed. Cincinnati OH: American Conference of Government Industrial Hygienists.

ACGIH [2023]. Industrial ventilation: a manual of recommended practice for design. 31st ed. Cincinnati, OH: American Conference of Government Industrial Hygienists.

ACS [2021]. Measurement uncertainty during weighing: top 8 contributors to watch out for. Chemical and Engineering News (C&EN) Whitepaper. Washington DC: American Chemical Society,

https://connect.acspubs.org/Sartorius_measurement_uncertainty?partnerref=CENonline.

AIChE [2005]. Guidelines for safe handling of powders and bulk solids. New York: Center for Chemical Process Safety, American Institute of Chemical Engineers, <https://doi.org/10.1002/9780470925072>.

Aitken RJ, Vincent JH, Mark D [1993]. Application of porous foams as size selectors for biologically relevant samplers. *Appl Occup Environ Hyg* 8(4):363–369, <https://doi.org/10.1080/1047322X.1993.10389221>.

Andreasen AHM, Hofman-Bang N, Rasmussen NH [1939]. Über das Staübungsvermögen der Stoffe [The dust-generating capacity of materials]. *Colloid Polym Sci* 86:70–77, (In German) <https://doi.org/10.1007/bf01512003>.

ANSI/ASSP [2021]. ANSI/ASSP Z590.3 Prevention through design guidelines for addressing occupational hazards and risks in design and redesign processes. Washington, DC: American National Standards Institute; Park Ridge, IL: American Society of Safety Professionals.

AS [2000]. AS 4156.6 Coal preparation. Part 6: Determination of dust/moisture relationship for coal. Australian Standards. Reconfirmed in 2013. Sydney, Australia: Standards Australia International.

ASTM [1980]. ASTM D547-41 Test method for index of dustiness of coal and coke. Withdrawn in 1986. West Conshohocken, PA: American Society for Testing and Materials International.



ASTM [1984]. ASTM D4331-84 Test method for effectiveness of dedusting agents for powdered chemicals. Withdrawn in 1988. West Conshohocken, PA: American Society for Testing and Materials International.

ASTM [2021]. ASTM D6393/D6393M Standard test method for bulk solids characterization by Carr indices—measurement of Carr dispersibility. West Conshohocken, PA: American Society for Testing and Materials International.

Bagnold RA [1941]. The physics of blown sand and desert dunes. London, UK: Methuen.

Baron PA, Estill CF, Deye GJ, Hein MJ, Beard JK, Larsen LD, Dahlstrom GE [2008]. Development of an aerosol system for uniformly depositing bacillus anthracis spore particles on surfaces. *Aerosol Sci Technol* 42(3):159–172, <https://doi.org/10.1080/02786820801918605>.

Bailey AG [1984]. Electrostatic phenomena during powder handling. *Powder Technol* 37(1):71–85, [https://doi.org/10.1016/0032-5910\(84\)80007-8](https://doi.org/10.1016/0032-5910(84)80007-8).

Berger-Schuun A, Geisenberger J, Kraymer M, Leaver AT, Oesch H-P, Russell DB, Uhrig H [1989]. Bestimmung des Staubverhaltens von Farbstoffen. *Melliand Textilberichte* 9:690–692. (In German).

Bishop L, Cena L, Orandle M, Yanamala N, Dahm MM, Birch ME, Evans DE, Kodali VK, Eye T, Battelli L, Zeidler-Erdely PC, Casuccio G, Bunker K, Lupoi JS, Lersch TL, Stefaniak AB, Sager T, Afshari A, Schwegler-Berry D, Friend S, Kang J, Siegrist KJ, Mitchell CA, Lowry DT, Kashon ML, Mercer RR, Geraci CL, Schubauer-Berigan MK, Sargent LM, Erdely A [2017]. In vivo toxicity assessment of occupational components of the carbon nanotube life cycle to provide context to potential health effects. *ACS Nano* 11(9):8849–8863, <https://doi.org/10.1021/acsnano.7b03038>.

BOHS [1985]. Dustiness estimation methods for dry materials. Part 1: Their uses and standardization. Part 2: Towards a standard method. Technical guide No. 4. By Hammond CM, Heriot NR, Higman RW, Spivey AM, Vincent JH, Wells AB. British Occupational Hygiene Society, Technology Committee, Working Group on Dustiness Estimation. Northwood, UK: Science Reviews Ltd.

BOHS [1988]. Progress in dustiness estimation: British Occupational Hygiene Society Technology Committee Working Party on Dustiness Estimation. *Ann Occup Hyg* 32(4): 535–544, <https://doi.org/10.1093/annhyg/32.4.535>.

BoM [1927]. Coal-dust explosion tests in the experimental mine 1919 to 1924, inclusive. By Rice GS, Paul JW, Greenwald HP. Pittsburgh, PA: U.S. Department of Commerce, Bureau of Mines, Bulletin 268, <https://www.cdc.gov/niosh/mining/works/coversheet72.html>.

Boundy M, Leith D, Polton T [2006]. Method to evaluate the dustiness of pharmaceutical powders. *Ann Occup Hyg* 50(5):453–458, <https://doi.org/10.1093/annhyg/mel004>.

Bransby PL [1977]. Current work in materials handling at Warren Spring Laboratory. *Chem Eng* 318:161–164.



Breum NO [1999]. The rotating drum dustiness tester: variability in dustiness in relation to sample mass, testing time, and surface adhesion. *Ann Occup Hyg* 43(8):557–566, [https://doi.org/10.1016/S0003-4878\(99\)00049-6](https://doi.org/10.1016/S0003-4878(99)00049-6).

Breum NO [2000]. The dust holding capacity of porous plastic foam used in particle size-selective sampling. *J Aerosol Sci* 31(3):379–385, [https://doi.org/10.1016/S0021-8502\(99\)00065-8](https://doi.org/10.1016/S0021-8502(99)00065-8).

Broßell D, Heunisch E, Meyer-Plath A, Bäger D, Bachmann V, Kämpf K, Dziurawitz N, Thim C, Wenzlaff D, Schumann J, Plitzko S [2019]. Assessment of nanofibre dustiness by means of vibro-fluidization. *Powder Technol* 342:491–508, <https://doi.org/10.1016/j.powtec.2018.10.013>.

Brouwer DH [2012]. Control banding approaches for nanomaterials. *Ann Occup Hyg* 56(5):506–514, <https://doi.org/10.1093/annhyg/mes039>.

Brouwer DH, Links IHM, De Vreed SAF, Christopher Y [2006]. Size selective dustiness and exposure; simulated workplace comparisons. *Ann Occup Hyg* 50(5):445–452, <https://doi.org/10.1093/annhyg/mel015>.

Brown RC [1980]. Porous foam size selectors for respirable dust samplers. *J Aerosol Sci* 11(2):151–159, [https://doi.org/10.1016/0021-8502\(80\)90031-2](https://doi.org/10.1016/0021-8502(80)90031-2).

Brunauer S, Emmett PH, Teller E [1938]. Adsorption of gases in multimolecular layers. *J Am Chem Soc* 60(2):309–319, <https://doi.org/10.1021/ja01269a023>.

Burdett G, Bard D, Kelly A, Thorpe A [2013]. The effect of surface coatings on the dustiness of a calcium carbonate nanopowder. *J Nanopart Res* 15:1311, <https://doi.org/10.1007/s11051-012-1311-9>.

Burdett GJ, Chung KYK, Mark D, Armbruster LA, Breum NO [2000]. Development of a method for dustiness testing. Sheffield, UK: Health and Safety Laboratory, Final report of EU contract SMT4-CT96-2074, HSE Report IR/L/MF/00/11.

Calvert G, Ghadiri M, Tweedie R [2009]. Aerodynamic dispersion of cohesive powders: a review of understanding and technology. *Adv Powder Technol* 20(1):4–16, <https://doi.org/10.1016/j.apt.2008.09.001>.

Cashdollar KL [2000]. Overview of dust explosibility characteristics. *J Loss Prev Process Ind* 13(3–5):183–199, [https://doi.org/10.1016/S0950-4230\(99\)00039-X](https://doi.org/10.1016/S0950-4230(99)00039-X).

Castellanos A [2005]. The relationship between attractive interparticle forces and bulk behavior in dry and uncharged fine powders. *Adv Phys* 54(4):263–376, <https://doi.org/10.1080/17461390500402657>.

CEN [1993]. EN481 Workplace atmospheres—size fraction definitions for measurement of airborne particles. Brussels, Belgium: Comité de Européen Normalisation, <https://standards.globalspec.com/std/969024/EN%20481>.

CEN [2006]. EN15051 Workplace atmospheres—measurement of the dustiness of bulk materials—requirements and test methods. Withdrawn and superseded by EN15051



Parts 1–3, 2013. Brussels, Belgium: Comité de Européen Normalisation, <https://standards.globalspec.com/std/72146/din-en-15051>.

CEN [2013a]. EN15051-1 Workplace exposure—measurement of the dustiness of bulk materials. Part 1: Requirements and choice of test methods. Brussels, Belgium Comité de Européen Normalisation, <https://standards.globalspec.com/std/1665435/din-en-15051-1>.

CEN [2013b]. EN15051-2 Workplace exposure—measurement of the dustiness of bulk materials. Part 2: Rotating drum method. Brussels, Belgium: Comité de Européen Normalisation, <https://standards.globalspec.com/std/10153290/din-en-15051-2>.

CEN [2013c]. EN15051-3 Workplace exposure—measurement of the dustiness of bulk materials. Part 3: Continuous drop method. Brussels, Belgium: Comité de Européen Normalisation, <https://standards.globalspec.com/std/1665455/din-en-15051-3>.

CEN [2019a]. EN17199-1 Workplace exposure—measurement of dustiness of bulk materials that contain or release respirable NOAA and other respirable particles. Part 1: Requirements and choice of test methods. Brussels, Belgium: Comité de Européen Normalisation, <https://standards.globalspec.com/std/14227540/din-en-17199-1>.

CEN [2019b]. EN17199-2 Workplace exposure—measurement of dustiness of bulk materials that contain or release respirable NOAA and other respirable particles. Part 2: Rotating drum method. Brussels, Belgium: Comité de Européen Normalisation, <https://standards.globalspec.com/std/14227544/din-en-17199-2>.

CEN [2019c]. EN17199-3 Workplace exposure—measurement of dustiness of bulk materials that contain or release respirable NOAA and other respirable particles. Part 3: Continuous drop method. Brussels, Belgium: Comité de Européen Normalisation, <https://standards.globalspec.com/std/14227547/din-en-17199-3>.

CEN [2019d]. EN17199-4 Workplace exposure—measurement of dustiness of bulk materials that contain or release respirable NOAA and other respirable particles. Part 4: Small rotating drum method. Brussels, Belgium: Comité de Européen Normalisation, <https://standards.globalspec.com/std/14230857/din-en-17199-4>.

CEN [2019e]. EN17199-5 Workplace exposure—measurement of dustiness of bulk materials that contain or release respirable NOAA and other respirable particles. Part 5: Vortex shaker method. Brussels, Belgium: Comité de Européen Normalisation, <https://standards.globalspec.com/std/13271325/ds-en-17199-5>.

Champmartin C, Clerc F [2014]. Inhalable dust measurements as a first approach to assessing occupational exposure in the pharmaceutical industry. *J Occup Environ Hyg* 11(2):85–92, <https://doi.org/10.1080/15459624.2013.843781>.

Chen H, Jog MA, Evans DE, Turkevich LA [2021]. Numerical investigation of powder aerosolization in a rotating drum apparatus. *Powder Technol* 390:62–72, <https://doi.org/10.1016/j.powtec.2021.04.102>.



Chen H, Jog MA, Turkevich LA [2023]. Computational fluid dynamics simulations of aerosol behavior in a high speed [Heubach] rotating drum dustiness tester. *Particuology* 72:68–80, <https://doi.org/10.1016/j.partic.2022.02.010>.

Cheng L [1973]. Formation of airborne-respirable dust at belt conveyor transfer points. *Am Ind Hyg Assoc J* 34(12):540–546, <https://doi.org/10.1080/0002889738506895>.

Chung KYK, Burdett GJ [1994]. Dustiness testing and moving towards a biologically relevant dustiness index. *Ann Occup Hyg* 38(6):945–949, <https://doi.org/10.1093/annhyg/38.6.945>.

Cleaver JAS, Tyrrell JWG [2004]. The influence of relative humidity on particle adhesion—a review of previous work and the anomalous behavior of soda-lime glass. *Kona* 22:9–22, <http://doi.org/10.14356/kona.2004008>.

Cocke JB, Perkins HH Jr., Bragg CK [1977]. Use of additives to reduce cotton dust levels. *Am Text Rep Bull Ed* 6(3):43–46.

Cocke JB, Perkins HH Jr., Getchell NF [1978]. Controlling dust in agricultural products with additives. *CFW Plex* 23(9):554–556.

Combs MP, Dickson RP [2020]. Turning the lungs inside out: the intersecting microbiomes of the lungs and the built environment. *Am J Respir Crit Care Med* 202(12):1618–1620, <https://doi.org/10.1164/rccm.202007-2973ed>.

Cowherd C Jr. [1981]. Control of windblown dust from storage piles. *Environ Int* 6(1–6):307–311, [https://doi.org/10.1016/0160-4120\(81\)90040-4](https://doi.org/10.1016/0160-4120(81)90040-4).

Cowherd C Jr., Grelinger MA, Englehart PJ, Kent RF, Wong KF [1989a]. An apparatus and methodology for predicting the dustiness of materials. *Am Ind Hyg Assoc J* 50(3):123–130, <https://doi.org/10.1080/15298668991374408>.

Cowherd C Jr., Grelinger MA, Wong KF [1989b]. Dust inhalation exposures from the handling of small volumes of powders. *Am Ind Hyg Assoc J* 50(3):131–138, <https://doi.org/10.1080/15298668991374417>.

CSB [2006]. Combustible dust hazard study. Washington DC: U.S. Chemical Safety and Hazard Investigation Board, Report No. 2006-H-1, https://www.csb.gov/assets/1/20/dust_final_report_website_11-17-06.pdf?13862.

CSB [2018]. Call to action: combustible dust. Washington DC: U.S. Chemical Safety and Hazard Investigation Board, https://www.csb.gov/assets/1/6/call_to_action_final1.pdf.

Dahm MM, Evans DE, Bertke SJ, Grinshpun SA [2019]. Evaluation of total and inhalable samplers for the collection of carbon nanotube and carbon nanofiber aerosols. *Aerosol Sci Technol* 53(8):958–970, <https://doi.org/10.1080/02786826.2019.1618437>.

Dahm MM, Evans DE, Schubauer-Berigan MK, Birch ME, Fernback, JE [2012]. Occupational exposure assessment in carbon nanotube and nanofiber primary and



secondary manufacturers. *Ann Occup Hyg* 56(5):542–56,
<https://doi.org/10.1093/annhyg/mer110>.

Dahmann D, Hartfiel GD, Mocklinghoff K [1997]. Method for the realistic determination of the dustiness of bulk materials. *Gefahrst Reinhalt Luft* 57:503–509. (In German).

Davies PN [1992]. The influence of shape on the strength of tablets. Thesis. London UK: School of Pharmacy, University of London,
<https://discovery.ucl.ac.uk/id/eprint/10124024/>.

Dennis R, Bubenick DV [1983]. Fugitive emissions control for solid materials handling operations. *J Air Pollut Control Assoc* 33(12):1156–1161,
<https://doi.org/10.1080/00022470.1983.10465706>.

DIN [1999]. DIN 55992-2 Determination of a parameter for the dust formation of pigments and extenders. Part 2: Drop method. Deutsches Institut für Normung (DIN). Berlin, Germany: Beuth Verlag (In German).

DIN [2002]. DIN 33897-2 Workplace atmospheres: determination of the dustiness of bulk materials. Part 2: Continuous drop. Withdrawn and superseded by DIN EN15051-3. Deutsches Institut für Normung (DIN). Berlin, Germany: Beuth Verlag (In German).

DIN [2006]. DIN 55992-1 Determination of a parameter for the dust formation of pigments and extenders. Part 1: Rotation method. Deutsches Institut für Normung (DIN). Berlin, Germany: Beuth Verlag (In German).

Dubey P, Ghia U, Turkevich LA [2017]. Computational fluid dynamics analysis of the Venturi dustiness tester. *Powder Technol* 312:310–320,
<https://doi.org/10.1016/j.powtec.2017.02.030>.

Eckhoff RK [2003]. *Dust explosions in process industries*. 3rd ed. New York: Gulf Professional Publishing, Elsevier Science.

EPA [2023]. Toxic Substances Control Act (TSCA) Chemical Substance Inventory. Washington DC: U.S. Environmental Protection Agency (EPA),
<https://www.epa.gov/tsca-inventory>.

EURAMET [2015]. Calibration Guide No. 18. Guidelines on the calibration of non-automatic weighing instruments. Version 4.0. Braunschweig, Germany: European Association of National Metrology Institutes (EURAMET),
[https://www.euramet.org/Media/docs/Publications/calguides/I-CAL-GUI-018 Calibration Guide No. 18 web.pdf](https://www.euramet.org/Media/docs/Publications/calguides/I-CAL-GUI-018%20Calibration%20Guide%20No.%2018%20web.pdf).

Evans DE, Heitbrink WA, Slavin TJ, Peters TM [2008]. Ultrafine and respirable particles in an automotive grey iron foundry. *Ann Occup Hyg* 52(1):9–21,
<https://doi.org/10.1093/annhyg/mem056>.

Evans DE, Ku BK, Birch ME, Dunn KH [2010]. Aerosol monitoring during carbon nanofiber production: mobile direct-reading sampling. *Ann Occup Hyg* 54(5):514–531,
<https://doi.org/10.1093/annhyg/meq015>.



- Evans DE, Turkevich LA, Roettgers CT, Deye GJ [2014]. Comment on comparison of powder dustiness methods. Letter to the editor. *Ann Occup Hyg* 58(4):524–528.
- Evans DE, Turkevich LA, Roettgers CT, Deye GJ, Baron PA [2013]. Dustiness of fine and nanoscale powders. *Ann Occup Hyg* 57(2):261–277, <https://doi.org/10.1093/annhyg/mes060>.
- Farrugia TR, Ahmed N, Jameson GJ [1989]. A new technique for measuring dustiness of coal. *J Coal Qual* 8(2):51–55.
- Fent KW, Durgam S, Mueller C [2014]. Pharmaceutical dust exposure at pharmacies using automatic dispensing machines: a preliminary study. *J Occup Environ Hyg* 11(11):695–705, <https://doi.org/10.1080/15459624.2014.918983>.
- Fraser K, Kodali V, Yanamala N, Birch ME, Cena L, Casuccio G, Bunker K, Lersch TL, Evans DE, Stefaniak A, Hammer MA, Kashon ML, Boots T, Eye T, Hubczak J, Friend SA, Dahm MM, Schubauer-Berigan MK, Siegrist K, Lowry D, Bauer AK, Sargent LM, Erdely A [2020]. Physicochemical characterization and genotoxicity of the broad class of carbon nanotubes and nanofibers used or produced in U.S. facilities. *Part Fibre Toxicol* 17(1):62, <https://doi.org/10.1186/s12989-020-00392-w>.
- Friedlander SK [2000]. *Smoke, dust and haze. Fundamentals of aerosol dynamics*. 2nd ed. Oxford UK: Oxford University Press.
- Gajjar P, Johnson CG, Carr J, Chrispeels K, Gray JMNT, Withers PJ [2021]. Size segregation of irregular granular materials captured by time-resolved 3D imaging. *Sci Rep* 11(1):8352, <https://doi.org/10.1038/s41598-021-87280-1>.
- Garrod A, Rajan-Sithamparanadarajah R [2003]. Developing COSHH essentials: dermal exposure, personal protective equipment and first aid. *Ann Occup Hyg* 47(7):577–588, <https://doi.org/10.1093/annhyg/meg089>.
- Gawol M, Adrian G [1983]. Sustainable, dust-free pigment and coloring preparation, procedure for its manufacturing and measuring appliance for same. Denmark patent No. DK350585-A, <https://patents.google.com/patent/DK350585A/en>.
- Gibson H, Vincent JH [1981]. The penetration of dust through porous foam filter media. *Ann Occup Hyg* 24(2):205–215, <https://doi.org/10.1093/annhyg/24.2.205>.
- Gillette DA, Blifford IH Jr., Fryrear DW [1974]. The influence of wind velocity on the size distributions of aerosols generated by the wind erosion of soils. *J Geophys Res* 79(27):4068–4075, <https://doi.org/10.1029/JC079i027p04068>.
- Gold G, Duvall RN, Palermo BT, Hurtle RL [1973]. Dustiness of pharmaceutical formulations. I. Instrumentation. *J Pharm Sci* 62(9):1530–1533, <https://doi.org/10.1002/jps.2600620934>.
- Goodfellow HD, Smith JW [1988]. Dustiness testing—a new approach for dust control. In: Vincent JH, ed. *Ventilation '88: Proceedings of the Second International Symposium on Ventilation for Contaminant Control*. Oxford, UK: Pergamon Press.



- Hamelmann F, Schmidt E [2003]. Methods of estimating the dustiness of industrial powders a review. *Kona* 21:7–18, <http://doi.org/10.14356/kona.2003006>.
- Hamelmann F, Schmidt E [2004]. Methods for characterizing the dustiness estimation of powders. *Chem Eng Technol* 27(8):844–847, <https://doi.org/10.1002/ceat.200403210>.
- Hammond CM [1980]. Dust control concepts in chemical handling and weighing. *Ann Occup Hyg* 23(1):95–109, <https://doi.org/10.1093/annhyg/23.1.95>.
- Hasleton PS [1972]. The internal surface area of the adult human lung. *J Anat* 112(Pt 3):391–400.
- Heitbrink WA, Baron PA, Willeke K [1992]. An investigation of dust generation by free falling powders. *Am Ind Hyg Assoc J* 53(10):617–624, <https://doi.org/10.1080/15298669291360256>.
- Heitbrink WA, Todd WF, Cooper TC, O'Brien DM [1990]. The application of dustiness tests to the prediction of worker dust exposure. *Am Ind Hyg Assoc J* 51(4):217–223, <https://doi.org/10.1080/15298669091369565>.
- Heitbrink WA, Todd WF, Fischbach TJ [1989]. Correlation of tests for material dustiness with worker exposure from the bagging of powders. *Appl Ind Hyg* 4:12–16.
- Higman RW, Schofield C, Taylor M [1984]. Bulk material dustiness, an important material property—its measurement and control. Paper presented at the 4th International Conference on Safety and the Environment, London, England, March 27–29.
- Hinds WC [1999]. *Aerosol technology: properties, behavior and measurement of airborne particles*. 2nd ed. New York: John Wiley and Sons, Inc.
- Hjemsted K, Schneider T [1996]. Documentation of a dustiness drum test. *Ann Occup Hyg* 40(6):627–643, [https://doi.org/10.1016/S0003-4878\(96\)00024-5](https://doi.org/10.1016/S0003-4878(96)00024-5).
- HSE [1996]. *Dustiness of powders and materials. Methods for the determination of hazardous substances (MDHS) 81*. MDHS 81 was first superseded by EN15051 in 2006. Bootle, England: United Kingdom Health and Safety Executive.
- HSE [2003]. *Safe handling of combustible dusts: precautions against explosions*. 2nd ed. Bootle, England: United Kingdom Health and Safety Executive, HSG103, <https://www.hse.gov.uk/pubns/priced/hsg103.pdf>.
- HSE [2010]. *A study to investigate ways to reduce the dustiness of bakery ingredients and exposure to allergens*. By Fraser S, Mason H, Thorpe A, Roberts P, Smith I, Evans G, Morton J, Mark D. Bootle, England: United Kingdom Health and Safety Executive, Research Report 830, <https://www.hse.gov.uk/Research/rrpdf/rr830.pdf>.
- HSE [2013]. *Dust in the workplace. General principles of protection*. 4th ed. Bootle, England: United Kingdom Health and Safety Executive, Guidance Note EH44, <https://www.hse.gov.uk/dust/assets/docs/eh44.pdf>.



HSE [2015]. The dust lamp: a simple tool for observing the presence of airborne particles. Methods for the determination of hazardous substances (MDHS) 82/2. Bootle, England: United Kingdom Health and Safety Executive, <https://www.hse.gov.uk/pubns/mdhs/pdfs/mdhs82-2.pdf>.

HSE [2017a]. Controlling airborne contaminants at work: a guide to local exhaust ventilation (LEV). 3rd ed. Health and safety guidance (HSG)258. Bootle, England: United Kingdom Health and Safety Executive, <https://www.hse.gov.uk/pubns/priced/hsg258.pdf>.

HSE [2017b]. COSHH essentials: controlling exposure to chemicals—a simple control banding approach. Bootle, England: United Kingdom Health and Safety Executive, <https://www.hse.gov.uk/pubns/guidance/coshh-technical-basis.pdf>.

HSE [2022]. Wood dust: controlling the risks. Information Sheet No. 23 (rev. 3). Bootle, England: United Kingdom Health and Safety Executive, WIS23(rev3), <https://www.hse.gov.uk/pubns/wis23.htm>.

IUPAC [1990]. Compendium of chemical terminology. 3rd ed. In: McNaught AD, Wilkinson A, eds. International Union of Pure and Applied Chemistry. Oxford, England: Blackwell Scientific Publications, <https://doi.org/10.1351/goldbook.D01867>.

ISO [1995]. ISO 7708 Air quality: particle size fraction definitions for health-related sampling. Reviewed and reconfirmed in 2017. Geneva, Switzerland: International Organization for Standardization.

ISO [2007]. ISO 14488 Particulate materials: sampling and sample splitting for the determination of particulate properties. Geneva, Switzerland: International Organization for Standardization.

ISO [2009]. ISO 15767 Workplace atmospheres: controlling and characterizing uncertainty in weighing collected aerosols. Geneva, Switzerland: International Organization for Standardization.

ISO [2014]. ISO/TS 12901-2:2014 Nanotechnologies: occupational risk management applied to engineered nanomaterials. Part 2: Use of the control banding approach. Geneva, Switzerland: International Organization for Standardization.

ISO [2021]. TS 12025 Nanomaterials: quantification of nano-object release from powders by generation of aerosols. Technical specification. Geneva, Switzerland: International Organization for Standardization.

ISO [2020]. ISO 4225 Air quality: general aspects: vocabulary. Geneva, Switzerland: International Organization for Standardization.

ISO [2022]. ISO 9277 Determination of the specific surface area of solids by gas adsorption—BET method. Geneva, Switzerland: International Organization for Standardization.

ISPE [2012]. Good practice guide: assessing particulate containment. 2nd ed. North Bethesda, MD: International Society for Pharmaceutical Engineering,



<https://ispe.org/publications/guidance-documents/assessing-particulate-containment-performance>.

Janhunan H, Nylander L, Heikkila P, Raunemaa T [1988]. Improved dustiness testing using a three-stage impactor. Paper presented at the 3rd Finnish Aerosol Symposium, June 21–22, Sipoo, Finland. Unpublished.

Jensen KA, Koponen IK, Clausen PA, Schneider T [2009]. Dustiness behaviour of loose and compacted Bentonite and organoclay powders: what is the difference in exposure risk? *J Nanopart Res* 11:133–146, <https://doi.org/10.1007/s11051-008-9420-1>.

Kenny LC, Gussman RA [1997]. Characterization and modelling of a family of cyclone aerosol preseparator. *J Aerosol Sci* 28(4):677–688, [https://doi.org/10.1016/S0021-8502\(96\)00455-7](https://doi.org/10.1016/S0021-8502(96)00455-7).

Ku BK, Deye G, Turkevich LA [2013]. Characterization of a vortex shaking method for aerosolizing fibers. *Aerosol Sci Technol* 47(12):1293–1301, <https://doi.org/10.1080/02786826.2013.836588>.

Levin M, Rojas E, Vanhala E, Vippola M, Liguori B, Kling KI, Koponen IK, Mølhav K, Tuomi T, Gregurec D, Moya S, Jensen KA [2015]. Influence of relative humidity and physical load during storage on dustiness of inorganic nanomaterials: implications for testing and risk assessment. *J Nanopart Res* 17:337, <https://doi.org/10.1007/s11051-015-3139-6>.

Lidén G [2006]. Dustiness testing of materials handled at workplaces. *Ann Occup Hyg* 50(5):437–439, <https://doi.org/10.1093/annhyg/mel042>.

López-Lilao A, Forner VS, Gasch GM, Monfort E [2017a]. Particle size distribution: a key factor in estimating powder dustiness. *J Occup Environ Hyg* 14(12):975–985, <https://doi.org/10.1080/15459624.2017.1358818>.

López-Lilao A, Gómez-Tena MP, Mallol G, Monfort E [2017b]. Clay hydration mechanisms and their effect on dustiness. *Appl Clay Sci* 144(5):157–164, <http://doi.org/10.1016/j.clay.2017.05.003>.

Lundgren, DA [1986]. A measurement technique to quantitate fugitive dust emissions from handling granular products. *J Aerosol Sci* 17(3):632–634, [https://doi.org/10.1016/0021-8502\(86\)90176-X](https://doi.org/10.1016/0021-8502(86)90176-X).

Lundgren DA, Rangaraj CN [1986]. A method for the estimation of fugitive dust emission potentials. *Powder Technol* 47(1):61–69, [https://doi.org/10.1016/0032-5910\(86\)80009-2](https://doi.org/10.1016/0032-5910(86)80009-2).

Lyons CP, Mark D [1992]. An evaluation of the roaches ‘dust particle apparatus’ dustiness testing equipment. Bootle, England: United Kingdom Health and Safety Executive, Contract Research Report No. 40/1992.

Lyons CP, Mark D [1994]. Development and testing of a procedure to evaluate the dustiness of powders and dusts in industrial use. Bootle, England: United Kingdom Health and Safety Executive, Contract Research Report No. 62/1994.



Lyons CP, Adam M, Mark D, Fish J, Chung K, Brammer J, Hammond CM, Tunnicliffe R, Fisher BT, Keech S, Rollings N, Sethi S, Chalmers C [1996]. Further development and testing of the HSE/WSL health related dustiness tester. Bootle, England: United Kingdom Health and Safety Executive, Contract Research Report No. 109/1996.

Lyons CP, Mark D, Chung KYK, Burdett G [1992]. The application of health-related size fractions to dustiness measurement. *J Aerosol Sci* 23(Suppl 1):S607–S610, [https://doi.org/10.1016/0021-8502\(92\)90485-E](https://doi.org/10.1016/0021-8502(92)90485-E).

Maynard AD [2007]. Nanotechnology: the next big thing, or much ado about nothing? *Ann Occup Hyg* 51(1):1–12, <https://doi.org/10.1093/annhyg/mel071>.

Maynard AD, Baron PA, Foley M, Shvedova AA, Kisin ER, Castranova V [2004]. Exposure to carbon nanotube material—aerosol release during the handling of unrefined single-walled carbon nanotube material. *J Toxicol Environ Health A* 67(1):87–107, <https://doi.org/10.1080/15287390490253688>.

Mettler-Toledo [2015]. Weighing the right way: guidelines for accurate results and better weighing techniques. Marcom, Switzerland: Mettler-Toledo, <https://www.mt.com/us/en/home/library/guides/laboratory-weighing/weighing-the-right-way.html>.

Munroe R [2020]. What makes sand soft? *New York Times*, Nov. 9, <https://www.nytimes.com/2020/11/09/science/what-makes-sand-soft.html>.

Neu-Baker NM, Eastlake AC, Brenner SA [2019]. Sample preparation method for visualization of nanoparticulate captured on mixed cellulose ester filter media by enhanced darkfield microscopy and hyperspectral imaging. *Microsc Res Tech* 82(6):878–883, <https://doi.org/10.1002/jemt.23231>.

NFPA [2019]. NFPA 652 Standard on the fundamentals of combustible dust. Quincy MA: National Fire Protection Association.

NFPA [2020]. NFPA 654 Standard for the prevention of fire and dust explosions from the manufacturing, processing, and handling of combustible particulate solids. Quincy MA: National Fire Protection Association.

NFPA [2021]. NFPA 499 Recommended practice for the classification of combustible dusts and of hazardous [classified] locations for electrical installations in chemical process areas. Quincy MA: National Fire Protection Association.

NFPA [2022]. NFPA 484 Standard for combustible metals. Quincy MA: National Fire Protection Association.

Nichols G, Byard S, Bloxham MJ, Botterill J, Dawson NJ, Dennis A, Diart V, North NC, Sherwood JD [2002]. A review of the terms agglomerate and aggregate with a recommendation for nomenclature used in powder and particle characterization. *J Pharm Sci* 91(10):2103–2109, <https://doi.org/10.1002/jps.10191>.

NIOSH [2006]. Float coal dust explosion hazards. Pittsburgh, PA: U.S. Department of Health and Human Services, Centers for Disease Control and Prevention, National



Institute for Occupational Safety and Health, DHHS (NIOSH) Publication No. 2006-125, <https://www.cdc.gov/niosh/mining/UserFiles/works/pdfs/2006-125.pdf>.

NIOSH [2009]. Quantitative risk characterization and management of occupational hazards: control banding (CB): a literature review and critical analysis. Cincinnati, OH: U.S. Department of Health and Human Services, Centers for Disease Control and Prevention, National Institute for Occupational Safety and Health, DHHS (NIOSH) Publication No. 2009-152, <https://www.cdc.gov/niosh/docs/2009-152/>.

NIOSH [2010]. Recommendations for a new rock dusting standard to prevent coal dust explosions in intake airways. By Cashdollar KL, Sapko MJ, Weiss ES, Harris ML, Man C-K, Harteis SP, Green GM. Pittsburgh, PA: U.S. Department of Health and Human Services, Centers for Disease Control and Prevention, National Institute for Occupational Safety and Health, DHHS (NIOSH) Publication No. 2010-151, RI 9679, <https://www.cdc.gov/niosh/mining/works/coversheet1326.html>.

NIOSH [2014a]. Current strategies for engineering controls in nanomaterial production and downstream handling processes. Cincinnati, OH: U.S. Department of Health and Human Services, Centers for Disease Control and Prevention, National Institute for Occupational Safety and Health, DHHS (NIOSH) Publication No. 2014-102, <https://www.cdc.gov/niosh/docs/2014-102/pdfs/2014-102.pdf>.

NIOSH [2014b]. Mining Product: EVADE software. Version 2.4.6. By Cecala AB, Cole GP, Reed WR, Britton J. Updated 2023. Pittsburgh, PA: U.S. Department of Health and Human Services, Centers for Disease Control and Prevention, National Institute for Occupational Safety and Health, DHHS (NIOSH) Publication No. 2014-134c, <https://www.cdc.gov/niosh/mining/Works/coversheet1867.html>.

NIOSH [2018a]. Personal protective equipment. Cincinnati, OH: U.S. Department of Health and Human Services, Centers for Disease Control and Prevention, National Institute for Occupational Safety and Health, <https://www.cdc.gov/niosh/ppe/default.html>.

NIOSH [2018b]. Controlling health hazards when working with nanomaterials: questions to ask before you start. Cincinnati, OH: U.S. Department of Health and Human Services, Centers for Disease Control and Prevention, National Institute for Occupational Safety and Health, DHHS (NIOSH) Publication No. 2018-103, <https://www.cdc.gov/niosh/docs/2018-103/default.html>.

NIOSH [2019]. Dust control handbook for industrial minerals mining and processing. 2nd ed. By Cecala AB, O'Brien AD, Schall J, Colinet JF, Franta RJ, Schultz MJ, Haas EJ, Robinson J, Patts J, Holen BM, Stein R, Weber J, Strebel M, Wilson L, Ellis M. Pittsburgh, PA: U.S. Department of Health and Human Services, Centers for Disease Control and Prevention, National Institute for Occupational Safety and Health, DHHS (NIOSH) Publication No. 2019-124, RI 9701, <https://doi.org/10.26616/NIOSH PUB2019124>.

NIOSH [2021a] Best practices for dust control in coal mining. 2nd ed. By Colinet JF, Halldin CN, Schall J. Pittsburgh, PA: U.S. Department of Health and Human Services, Centers for Disease Control and Prevention, National Institute for Occupational Safety



and Health, DHHS (NIOSH) Publication No. 2021-119,
<https://doi.org/10.26616/NIOSHPUB2021119>.

NIOSH [2021b] Measuring respirable aerosol with real-time optical monitors. Chapter AM. By Cauda E. In: Manual of analytical methods. 5th ed. Andrews R, O'Connor PF, eds. Cincinnati, OH: U.S. Department of Health and Human Services, Centers for Disease Control and Prevention, National Institute for Occupational Safety and Health,
<https://www.cdc.gov/niosh/nmam/pdf/chapter-am.pdf>.

NIOSH [2023]. Hierarchy of controls. Cincinnati, OH: U.S. Department of Health and Human Services, Centers for Disease Control and Prevention, National Institute for Occupational Safety and Health,
<https://www.cdc.gov/niosh/topics/hierarchy/default.html>.

O'Farrell P, Vaughan NP [1986]. Evaluation of a test method for the dustiness of bulk material. Bootle, England: United Kingdom Health and Safety Executive, Report No. IR/L/DS/86/2.

OSHA [1998]. CFR Part 1910.134 Respiratory protection. Washington, DC: U.S. Department of Labor, Occupational Safety and Health Administration,
<https://www.osha.gov/laws-regs/regulations/standardnumber/1910/1910.134>.

OSHA [2005]. Combustible dust in industry: preventing and mitigating the effects of fire and explosions. Washington DC: U. S. Department of Labor, Occupational Safety and Health Administration, SHIB 07-31-2005,
<https://www.osha.gov/sites/default/files/publications/shib073105.pdf>.

OSHA [2020]. Combustible dusts. OSHA Notice to add combustible dusts to OSHA technical manual, Chapter 6, Section IV. Washington, DC: U.S. Department of Labor, Occupational Safety and Health Administration,
https://www.osha.gov/sites/default/files/otm_secIV_chap6.pdf.

O'Shaughnessy PT, Kang M, Ellickson D [2012]. A novel device for measuring respirable dustiness using low-mass powder samples. *J Occup Environ Hyg* 9(3):129–139,
<https://doi.org/10.1080/15459624.2011.652061>.

Paik SY, Zalk DM, Swuste P [2008]. Application of a pilot control banding tool for risk level assessment and control of nanoparticle exposures. *Ann Occup Hyg* 52(6):419–428,
<https://doi.org/10.1093/annhyg/men041>.

Palakurthi NK, Ghia U, Turkevich LA [2017]. Simulations of particle detachment from a flat surface. In: Conference Proceedings of the ASME 2017 Fluids Engineering Division Summer Meeting, FEDSM 2017-69111, <https://doi.org/10.1115/FEDSM2017-69111>.

Palakurthi NK, Ghia U, Turkevich LA [2022]. Numerical investigation of aerosolization in the Venturi dustiness tester: aerodynamics of a particle on a hill. *J Fluids Eng* 144(6):061113, <https://doi.org/10.1115/1.4054099>.



- Pensis I, Mareels J, Dahmann D, Mark D [2010]. Comparative evaluation of the dustiness of industrial minerals according to European Standard EN 15051. *Ann Occup Hyg* 54(2):204–216, <https://doi.org/10.1093/annhyg/mep077>.
- Perera IE, Sapko MJ, Harris ML, Zlochower IA, Weiss ES [2016]. Design and development of a dust dispersion chamber to quantify the dispersibility of rock dust. *J Loss Prev Process Ind* 39:7–16, <https://doi.org/10.1016/j.jlpp.2015.11.002>.
- Petavratzi E, Kingman SW, Lowndes IS [2007]. Assessment of the dustiness and the dust liberation mechanisms of limestone quarry operations. *Chem Eng Process* 46(12):1412–1423, <https://doi.org/10.1016/j.cep.2006.11.005>.
- Plinke MAE, Leith D, Boundy MG, Loffler F [1995]. Dust generation from handling powders in industry. *Am Ind Hyg Assoc J* 56(3):251–257, <https://doi.org/10.1080/15428119591017088>.
- Powell AR, Russell CC [1933]. Method for determining the dustiness of coal and coke. *Anal Chem* 5(5):340–341.
- Pujara CP [1997]. Determination of factors that affect the generation of airborne particles from bulk pharmaceutical powders. Thesis. West Lafayette, IN: Purdue University, <https://docs.lib.purdue.edu/dissertations/AAI9808505/>.
- Rabinovich YI, Adler JJ, Esayanur MS, Ata A, Singh RK, Moudgil BM [2002]. Capillary forces between surfaces with nanoscale roughness. *Adv Colloid Interface Sci* 96(1–3):213–230, [https://doi.org/10.1016/s0001-8686\(01\)00082-3](https://doi.org/10.1016/s0001-8686(01)00082-3).
- Ribalta C, López-Lilao A, Estupiñá S, Fonseca AS, Tobías A, García-Cobos A, Minguillón MC, Montfort E, Viana M [2019a]. Health risk assessment from exposure to particles during packing in working environments. *Sci Total Environ* 671:474–487, <https://doi.org/10.1016/j.scitotenv.2019.03.347>.
- Ribalta C, Viana M, López-Lilao A, Estupiñá S, Minguillón MC, Mendoza J, Díaz J, Dahmann D, Monfort E [2019b]. On the relationship between exposure to particles and dustiness during handling of powders in industrial settings. *Ann Work Expo Health* 63(1):107–123, <https://doi.org/10.1093/annweh/wxy092>.
- Roesler JF [1966]. Application of polyurethane foam filters for respirable dust separation. *J Air Pollut Control Assoc* 16(1):30–34, <https://doi.org/10.1080/00022470.1966.10468437>.
- Rosén G, Andersson I-M, Walsh PT, Clark RDR, Säämänen A, Heinonen K, Riipinen H, Pääkkönen R [2005]. A review of video exposure monitoring as an occupational hygiene tool. *Ann Occup Hyg* 49(3):201–217, <https://doi.org/10.1093/annhyg/meh110>.
- Schneider T, Jensen KA [2008]. Combined single-drop and rotating drum dustiness test of fine to nanosize powders using a small drum. *Ann Occup Hyg* 52(1):23–34, <https://doi.org/10.1093/annhyg/mem059>.
- Schofield C, Sutton HM, Waters KAN [1979]. The generation of dust by materials handling operations. *J Powder Bulk Solids Technol* 3(1):40–44.



- Sethi SA, Schneider T [1996]. A gas fluidization dustiness tester. *J Aerosol Sci* 27(Suppl 1):S305–S306, <https://doi.org/10.1016/0021-8502%2896%2900225-X>.
- Sharma A, Ghia U, Turkevich LA [2020a]. Effect of vortex shedding on the aerosolization of a particle from a hill using large eddy simulation. In: Proceedings of the 2020 AIAA Aviation Forum, virtual, July 15–19, <http://doi.org/10.2514/6.2020-2988>.
- Sharma A, Ghia U, Turkevich LA [2020b]. Large eddy simulation of flow over a hemispherical obstacle within a cylindrical tube. In: Conference Proceeding of the ASME 2020 Fluids Engineering Division Summer Meeting, FEDSM 2020-10596, <http://doi.org/10.1115/FEDSM2020-20165>.
- Stauber D, Beutel R [1984]. Determination and control of the dusting potential of feed premixes. *Fresenius J Anal Chem* 318:522–524, <https://doi.org/10.1007/BF00678754>.
- Sutter SL, Johnston JW, Mishima J [1982]. Investigation of accident-generated aerosols: releases from free fall spills. *Am Ind Hyg Assoc J* 43(7):540–543, <https://doi.org/10.1080/15298668291410170>.
- Taylor M [1984]. The measurement and control of material dustiness and attrition. Stevenage, UK: Warren Spring Laboratory, Report No. CR 2709(PA).
- Totaro S, Cotogno G, Rasmussen K, Pianella F, Roncaglia M, Olsson H, Riego Sintes JM, Crutzen HP [2016]. The JRC Nanomaterials Repository: a unique facility providing representative test materials for nanoEHS research. *Regul Toxicol Pharmacol* 81:334–340, <https://doi.org/10.1016/j.yrtph.2016.08.008>.
- Vincent JH [1995]. *Aerosol science for industrial hygienists*. Oxford, UK: Pergamon, Elsevier Science Ltd., <https://doi.org/10.1016/B978-0-08-042029-5.X5000-4>.
- Vincent JH [2007]. *Aerosol sampling: science, standards. instrumentation and applications*. West Sussex, UK: John Wiley and Sons Ltd., <https://doi.org/10.1002/9780470060230>.
- Vincent JH, Aitken RJ, Mark D [1993]. Porous plastic foam filtration media: penetration characteristics and applications in particle size-selective sampling. *J Aerosol Sci* 24(7):929–944, [https://doi.org/10.1016/0021-8502\(93\)90072-H](https://doi.org/10.1016/0021-8502(93)90072-H).
- Visser GTh [1992]. A wind-tunnel study of the dust emissions from the continuous dumping of coal. *Atmos Environ, Part A* 26(8):1453–1460, [https://doi.org/10.1016/0960-1686\(92\)90130-D](https://doi.org/10.1016/0960-1686(92)90130-D).
- Visser J [1976]. Adhesion of colloid particles. *Surf Colloid Sci* 8:3–79.
- Wells AB, Alexander DJ [1978]. A method for estimating the dust yield of powders. *Powder Technol* 19(2):271–277, [https://doi.org/10.1016/0032-5910\(78\)80036-9](https://doi.org/10.1016/0032-5910(78)80036-9).
- Whitby KT, Lundgren DA, McFarland AR, Jordon RC [1961]. Evaluation of air cleaners for occupied spaces. *J Air Pollut Control Assoc* 11:503–515, <https://doi.org/10.1080/00022470.1961.10468030>.



WHO [1997] Determination of airborne fibre number concentrations: a recommended method, by phase-contrast optical microscopy (membrane filter method). Geneva, Switzerland: World Health Organization,

<https://apps.who.int/iris/bitstream/handle/10665/41904/9241544961.pdf>.

WHO [1999]. Hazard prevention and control in the work environment: airborne dust. Geneva, Switzerland: World Health Organization,

<http://apps.who.int/iris/handle/10665/66147>.

WHO/ILO [2021]. Joint estimates of the work-related burden of disease and injury, 2000–2016: a global monitoring report. Geneva, Switzerland: World Health Organization and International Labor Organization,

<https://www.who.int/publications/i/item/9789240034945>.

Zalk DM, Nelson DI [2008]. History and evolution of control banding: a review. J Occup Environ Hyg 5(5):330–346, <https://doi.org/10.1080/15459620801997916>.